

USERS MANUAL



Information



Table of Contence

USER'S MANUAL FOR THE

SummaSign

T-Series **PRO**

IMPORTANT

Before you begin...

Please complete the attached Warranty Registration Card and return it to Summa today or go through the online registration at <http://www.summa.be/registration.html>. (Users outside Europe, Africa and the Middle East should check the address on the back of the Warranty Registration Card.)

Failure to return the duly completed Warranty Registration Card or Online registration might delay response to your warranty and service enquiries.

NOTE

When selecting software drivers: If the Summa name is not mentioned in the list of available software drivers, use Summagraphics drivers.



FCC NOTICE

The SummaSign Pro T-series cutters have been tested and found to comply with the limits for a Class A digital device, pursuant to Part 15 of the FCC Rules. These limits are designed to provide reasonable protection against harmful interference when the equipment is operated in a commercial environment. These cutters generate, use, and can radiate radio frequency energy and, if not installed and used in accordance with the instruction manual, may cause harmful interference to radio communications. Operation of these cutters in a residential area is likely to cause harmful interference in which case the user will be required to correct the interference at his own expense.

Caution !

Changes or modifications, not expressly approved by Summa, who is responsible for FCC compliance, could void the users authority to operate this equipment.

DOC NOTICE

The SummaSign Pro T-series cutters do not exceed the Class A limits for radio noise for digital apparatus set out in the Radio Interference Regulations of the Canadian Department of Communications.

NOTICE

Summa reserves the right to modify the information contained in this User Manual at any time without prior notice. Unauthorised copying, modification, distribution or display is prohibited. All rights reserved. All queries, comments or suggestions concerning this and other Summa manuals should be directed to:

Americas and Asia Pacific

Summa Inc.
10001 Lake City Way NE
SEATTLE, WA 98125
USA

Tel +(01) 206-527-1050
Fax +(01) 206-527-1046

E-mail support@summausa.com

Europe

Summa NV
Rochesterlaan 6
8470 GISTEL
Belgium

Tel +32 59 270011
Fax +32 59 270063

E-mail summanv@summa.be

© Copyright 1999, Summa N.V.

Notice

TRADEMARK ACKNOWLEDGEMENTS

3M and Scotchcal are trademarks of the 3M Corp.

Arlon is a trademark of Keene Corp.

DM/PL and Houston Instrument are trademarks of Summagraphics Corporation.

Fasson is a trademark of Avery.

Gerber is a trademark of Gerber Scientific Products, Inc.

Grafitack is a trademark of Grafityp.

HP-GL is a trademark of Hewlett-Packard Company.

IBM PC, IBM PC/XT, and IBM AT are trademarks of International Business Machines Corp.

Kapco is a trademark of Kent Adhesive Products Co.

Macintosh, Macintosh Plus, Macintosh SE, and Macintosh II are trademarks of Apple Computer.

MACTac is a trademark of MACTac Europe.

Multifix is a trademark of Multiplast Grafics.

Rubylith is a trademark of Ulano.

Tesa and Tesacal are trademarks of Tesa.

TABLE OF CONTENTS		Page
1.	GENERAL INFORMATION	
1.1.	Introduction	1-1
1.1.1.	Product features.....	1-1
1.1.2.	SummaSign Pro T-series User Manual.....	1-3
1.2.	Specifications	1-4
1.2.1.	Cutter	1-4
1.2.2.	Media	1-4
1.2.3.	Knives, balpoint pen and pouncing tool	1-6
1.2.4.	Interface.....	1-6
1.2.5.	Firmware.....	1-7
1.2.6.	Performance.....	1-7
1.2.7.	Certifications	1-7
1.2.8.	Environmental.....	1-8
1.2.9.	Electrical	1-8
1.3.	Cutter options, accessories and consumables	1-9
1.4.	Rear panel components	1-10
1.5.	Front panel controls	1-12
1.6.	Powering up the cutter	1-14
1.6.1.	Earthing	1-14
1.6.2.	Power-up procedure	1-15
1.7.	Installation of a knife, pen or pouncing tool	1-16
1.7.1.	Installing a standard tangential knife	1-16
1.7.2.	Installing a knife for cutting masking stencil or heavy materials.....	1-20
1.7.3.	Installing a drag knife.....	1-21
1.7.4.	Installing a ballpoint pen	1-23
1.7.5.	Installing a pouncing tool.....	1-24
1.8.	Loading media	1-26
1.8.1.	Positioning the pinch rollers	1-26
1.8.2.	Feeding and positioning media.....	1-27
1.9.	Media load procedure	1-31

2. OPERATION

2.1. The control panel	2-1
2.1.1 The liquid crystal display	2-2
2.1.2 The Reset/Load key	2-2
2.1.3 The Online key	2-3
2.1.4 The Menu key	2-3
2.1.5 The Enter key	2-5
2.1.6 The 1 and 2 keys	2-5
2.1.7 The jogging keys	2-5
2.1.8 The Tool Up/Down key	2-5
2.1.9 The Tool Select key	2-6
2.2. Normal Operation	2-7
2.2.1 On line and off line	2-7
2.2.2 Local operation	2-8
2.3. The USER CONFIG menu	2-9
2.3.1 Knife pressure	2-11
2.3.2 Pen pressure	2-11
2.3.3 Pouncing pressure	2-11
2.3.4 Knife offset	2-11
2.3.5 Pouncing gap	2-12
2.3.6 Velocity	2-12
2.3.7 Overcut	2-12
2.3.8 System setup	2-12
2.4. System setup	2-13
2.4.1 Concatenation	2-13
2.4.2 Smoothing	2-13
2.4.3 Emulate	2-13
2.4.4 Tool	2-14
2.4.5 Menu units	2-14
2.4.6 Addressing	2-14
2.4.7 Baud rate	2-14
2.4.8 Parity	2-15
2.4.9 RTS/DTR	2-15
2.4.10 DM/PL errors	2-16
2.4.11 HP/GL errors	2-16
2.4.12 HP/GL origin	2-16
2.4.13 Media sensors	2-17
2.4.14 Autoload	2-17
2.4.15 Tool command	2-17
2.4.16 LOAD ON W CMD	2-17
2.4.17 FLEX-CUT	2-18

2.4.18	Recut offset.....	2-18
2.5.	Internal test menu	2-19
2.5.1	Tangential knife calibration.....	2-20
2.5.1.1	Adjust Origin test routine.....	2-22
2.5.1.2	Adjust Lat. test routine.....	2-23
2.5.1.3	Adjust Long test routine	2-24
2.5.2	Cut border	2-25
2.5.3	Menu plot.....	2-25
2.5.4	Confidence cut.....	2-26
2.5.5	DIN plot	2-26
2.5.6	System tests	2-26
2.6	System tests.....	2-27
2.6.1	Language	2-27
2.6.2	ROM revision	2-27
2.6.3	Service plot.....	2-27
2.6.4	Sensor setup.....	2-28
2.6.5	Calibration	2-28
2.6.6	Tracking test	2-28
2.6.7	Friction plot	2-28
2.6.8	RS232 test	2-28
2.6.9	RAM test	2-29
2.6.10	Install menu	2-29
2.6.11	Setup coil	2-29
2.6.12	LCD contrast	2-29
3.	MAINTENANCE AND CLEANING	
3.1.	Maintenance	3-1
3.1.1	Cleaning the drive system.....	3-1
3.1.2	Cleaning the sensors.....	3-2
3.1.3	Cleaning the nose piece.....	3-3
3.2.	Operating voltage conversion	3-4
4.	INTERFACE	
4.1.	Introduction.....	4-1
4.2.	Interface notes.....	4-1
4.2.1	System setup.....	4-1
4.2.1.1	MS-DOS or PC-DOS generating system	4-1
4.2.1.2	Windows 3.xx.....	4-2
4.2.1.3	Windows 95	4-2

4.2.2 Serial interface connector on cutter4-3

4.2.3 Parallel interface connector on cutter4-3

4.3. Available serial signals4-4

5 CONTOUR CUTTING

5.1 Introduction.....5-1

5.2 General (see section 6 for the actual procedure details)5-5

5.3 Creating the design5-5

5.4 Placing the Cross-marks5-6

5.5 Printing the design.....5-7

5.6 Loading the cutter and setting the parameters5-8

5.7 Registrating the cross-marks5-9

5.8 Cutting the contour5-11

APPENDIX A:

Media certification A-1

LIST OF ILLUSTRATIONS

1-1 SummaSign Pro T-series cutter, rear view1-10

1-2 SummaSign Pro T-series cutter, front view1-12

1-3 Earth connection.....1-15

1-4 Standard knife assembly1-16

1-5 Nose piece installation1-17

1-6 Knife holder insertion.....1-17

1-7 Knife depth adjustment1-18

1-8 Knife depth test pattern.....1-19

1-9 Sandblast knife assembly 1-20

1-10 Nose piece and knife installtion for cutting masking stencils or heavy materials.....1-21

1-11 Drag knife assembly.....1-22

1-12 Drag knife holder insertion.....1-22

1-13 Ballpoint pen assembly1-23

1-14 Ballpoint holder insertion1-24

1-15	Media positioning.....	1-27
1-16	Feeding roll media using media flanges	1-28
1-17	Feeding roll media without	1-29
1-18	Pinch roller positioning	1-29
2-1	SummaSign Pro T-series cutter, control panel	2-1
2-2	Configuration submenus	2-4
2-3	Flowchart showing factory preset menu settings.....	2-10
2-4	Internal tests submenus	2-20
2-5	Possible knife calibration grounds	2-21
3-1	Cleaning of the media drive sleeves	3-2
3-2	Location of the sensors	3-2
3-3	Power entry module	3-4

LIST OF TABLES

1-1	SummaSign Pro T-series cutter specifications	1-4
1-2	SummaSign Pro T-series media specifications	1-4
1-2	SummaSign Pro T-series media specifications (cont'd).....	1-5
1-3	SummaSign Pro T-series knives, ballpoint pen and pouncing tool	1-6
1-4	SummaSign Pro T-series interface specifications	1-6
1-5	SummaSign Pro T-series firmware.....	1-7
1-6	SummaSign Pro T-series performances.....	1-7
1-7	SummaSign Pro T-series environmental specifications.....	1-8
1-8	SummaSign Pro T-series electrical specifications	1-8
1-9	SummaSign Pro T-series accessories and consumables.....	1-9
2-1	Contents of the SummaSign Pro T-series menus.....	2-5

SECTION 1

GENERAL INFORMATION

1.1. INTRODUCTION

The SummaSign range of cutters has been designed to produce computer-generated graphic designs on cut sheet or roll vinyl media. By replacing the knife with a ballpoint pen, these cutters can also be used to produce inexpensive previews of new graphic designs on paper.

This manual is a reference guide for installing and operating the SummaSign Pro T-series cutter models. These cutter models feature a tangential head indicated by the 'T' prefix to the product designation.

This manual covers the following SummaSign Pro T-series cutter models :

- The SummaSign T750 Pro, which can handle media widths from 60 mm up to 762 mm (2.4" to 30").
- The SummaSign T1010 Pro, which can handle media widths from 110 mm up to 1020 mm (4" to 40").
- The SummaSign T1400 Pro, which can handle media widths from 110 mm up to 1370 mm (4" to 54").

The term 'Pro T-series cutters' is used when information is provided which is common to all members of this series. The specific model terms T750 Pro, T1010 Pro and T1400 Pro are used if information pertains only to that particular model.

1.1.1. PRODUCT FEATURES

The following are the main features of the SummaSign Pro T-series cutters.

- Variable media widths.
- User-selectable DM/PL™, HP/GL™ and HP/GL/2™ software languages.
- Interchangeable drag knife

- Interchangeable ballpoint pen for producing preview plots of sign designs on paper.
- Interchangeable pouncing tool.
- Adjustable knife pressure (and offset settings) controlled by microprocessor.
- Communication with host computer via standard serial RS-232-C or Centronics parallel interface.
- 12-key control panel.
- Metric or English units.
- User-addressable resolution : 0.1 mm, 0.025 mm, 0.001" or 0.005".
- Menu mode for selection of the cutter's power-up operating configuration.
- Convenient operator control via a 2-line 16-character liquid crystal display.
- Extensive internal test routines.
- Wide variety of cutting speeds (in metric or English units).
- Up to four separate user configurations stored in non-volatile memory.
- Media support system for automatic loading of media with optional "shuffling" to guarantee tracking of longer signs.
- Automatic media pull from roll.
- Media sensing.
- Simple origin adjustment to any location.
- Concatenation and curve smoothing to obtain better cut quality.
- Multiple recut feature.
- Re-cut of last file.
- Knife depth and offset test.
- Overcut for easy weeding.

1.1.2. SUMMASIGN PRO T-SERIES USER MANUAL

This user manual provides the following information :

- Full technical specifications for the SummaSign Pro T-series cutters and the media to be cut.
- A complete description of the SummaSign Pro T-series main components.
- Step-by-step instructions for knife and ballpoint pen installation and media loading.
- Instructions for online and local mode () operations.
- Instructions for USER CONFIGURATION and INTERNAL TESTS operations.
- Maintenance and cleaning instructions.
- Information about the RS-232-C and Centronics interface cables used to inter-connect the cutter and IBM, IBM-compatible, Apple and Apple-compatible host computers.

1.2. SPECIFICATIONS

1.2.1. CUTTER

		T750 Pro		T1010 Pro		T1400 Pro	
		with optional stand		with standard stand		with standard stand	
		mm	inch	mm	inch	mm	inch
Height	without stand	265	10.43	265	10.43	265	10.43
	with stand	1100	43.31	1100	43.31	1100	43.31
Width	without stand	1270	50.00	1670	65.75	2015	79.33
	with stand	1270	50.00	1670	65.75	2015	79.33
Depth	without stand	550	21.65	550	21.65	550	21.65
	with stand	550	21.65	550	21.65	550	21.65
Weight	without stand	31 kg	68 lbs	38 kg	84lbs	43 kg	93 lbs
	with stand	46 kg	101 lbs	54 kg	119 lbs	61 kg	134 lbs

TABLE 1-1 :
SUMMASIGN PRO T-SERIES CUTTER SPECIFICATIONS

1.2.2. MEDIA

	T750 Pro		T1010 Pro		T1400 Pro	
	mm	inch	mm	inch	mm	inch
Width	70 to 762	2.4 to 30	110 to 1020	4 to 40	110 to 1370	4 to 54
Max width	Sheets & rolls up to 762 mm (30") wide can be accommodated		Sheets & rolls up to 1200 mm (47") wide can be accommodated		Sheets & rolls up to 1545 mm (61") wide can be accommodated	
Tracking Performance	- 12 m/39 feet max. within guaranteed specifications * for media less than 750 mm (30") wide. - 4 m/13 feet max. within guaranteed specifications ** for media larger than 750 mm (30").					

TABLE 1-2 :
SUMMASIGN PRO T-SERIES MEDIA SPECIFICATIONS

	T750 Pro		T1010 Pro		T1400 Pro	
	mm	inch	mm	inch	mm	inch
Thickness	0.05 to 1.2	0.002 to 0.050	0.05 to 1.2	0.002 to 0.050	0.05 to 1.2	0.002 to 0.050
Max.cutting/plotting area	720	27.7	995	39.2	1345	53
Min. Margin***						
Unperforated	25	1.0	25	1.0	25	1.0
Perforated	55	2.2	55	2.2	55	2.2
Front Margin	25	1.0	25	1.0	25	1.0
Rear Margin						
Sensor on	42	1.7	42	1.7	42	1.7
Sensor off	30	1.2	30	1.2	30	1.2

* Media lengths greater than 12 m (39 feet) can be handled, but compliance with specifications is not guaranteed (will be dependent on media type, media size and other parameters).

** Media lengths greater than 4 m (13 feet) can be handled, but compliance with specifications is not guaranteed (will be dependent on media type, media size and other parameters).

*** for positioning of the pinch rollers (see section 1.8.)

TABLE 1-2 :
SUMMASIGN PRO T-SERIES MEDIA SPECIFICATIONS (CONT'D)

Vinyl Types

A wide range of vinyl types has been evaluated and tested on the SummaSign Pro T-series cutters. When using duly certified media, operation in accordance with the functional specifications of the model is warranted. Other media should be certified by CalComp before use to ensure performance in compliance with specifications.

For a full list of all duly certified media suitable for friction drive operation, see Appendix A.

Plotting Paper

Bond paper (120 g/m² recommended)

1.2.3. KNIVES BALLPOINT PEN AND POUNCING TOOL

The SummaSign Pro cutters are supplied with two standard knives (for vinyl media), one masking stencil knife, one drag knife and one black ballpoint pen.

Tangential Knife	Medium	Quantity supplied
Standard knife (requires a standard knife holder along with a standard grey nose piece)	standard, reflective & fluorescent vinyl types	2 off 2 off
Double tip knife for high-density reflective materials (requires a standard knife holder)	high-density reflective vinyl types	optional
Knife for masking stencils (requires a standard knife holder along with black nose piece)	masking stencils & thick materials	1 off 1 off 1 off
Drag Knife		
Standard drag knife (requires a drag knife holder)	standard, reflective & fluorescent vinyl types	1 off 1 off
Pen	<i>Colour</i>	<i>Quantity</i>
Ballpoint pen (requires a ballpoint pen holder)	black	1 off 1 off
Pouncing Tool	Paper	optional

TABLE 1-3 :
SUMMASIGN PRO T-SERIES KNIVES, PENS AND POUNCING TOOLS

To order replacement knives, pens and/or pouncing tools, contact your local dealer, quoting the part numbers listed in table 1-9. The SummaSign Pro cutters will only perform according to specifications if a Summagraphics genuine knife, pen is installed. Do not replace the standard knife, pen or pouncing tool with products from other manufacturers.

1.2.4. INTERFACE

Communication	standard asynchronous RS-232-C and Centronics parallel interface
Serial : I/O Port connector	DB-9P
Mating connector	DB-9S
Byte format	8 data bits, 2 stop bits, no parity
Baud rate	38400, 19200, 9600, 4800, 2400 bps
Parallel : I/O Port connector	Centronics female
Mating connector	Centronics male

TABLE 1-4 :
SUMMASIGN PRO T-SERIES INTERFACE SPECIFICATIONS

1.2.5. FIRMWARE

Language	DM/PL, HP/GL (758x emulation), HP/GL/2
Supported character sets	Standard ASCII
Supported fonts	Sans serif (single stroke & medium)
ROM-based plots	Confidence plot, DIN plot

TABLE 1-5 :
SUMMASIGN PRO T-SERIES FIRMWARE

1.2.6. PERFORMANCE

Cutting specifications on 0.05 mm (0.002") wax-backed vinyl, total media thickness not greater than 0.25 mm (0.010")

Axial speed	50 to 1000 mm/s	2 to 40 ips
Default speed	800 mm/s	32 ips
Acceleration	3 G	3 G
Addressable resolution	0.025 mm, 0.1 mm	0.001", 0.005"
Default resolution	0.025 mm	0.001"
Mechanical resolution	0.0127 mm	0.0005"
Accuracy	0.2% of move or 0.25 mm, whichever is greater*	0.2% of move or 0.010", whichever is greater*
Knife pressure	0 to 600 gr.	0 to 600 gr.
Pen pressure	0 to 600 gr.	0 to 600 gr.
Pouncing pressure	0 to 600 gr.	0 to 600 gr.

*Excludes differences due to media expansion, stretching, etc.

TABLE 1-6 :
SUMMASIGN PRO T-SERIES PERFORMANCES

1.2.7. CERTIFICATIONS

CE Certificate
 FCC Class A
 Comply with UL 1950, CSA 950

1.2.8. ENVIRONMENTAL

(cutter without media)

Operating Temperature	15 to 35° C	59 to 95° F
Storage temperature	-30 to 70° C	-22 to 158° F
Relative humidity	35 - 85 %, non con- densing	35 - 85 %, non con- densing

TABLE 1-7 :
SUMMASIGN PRO T-SERIES ENVIRONMENTAL SPECIFICATIONS



IMPORTANT HINT

The use of dimensionally stable media is an essential pre-requisite to obtaining high cut quality. Additionally, media expansion or contraction may occur as a result of temperature variations. To improve the dimensional stability of media, let it stabilize to the current environmental conditions before usage, for a minimum period of 24 hours.

1.2.9. ELECTRICAL

Mains Supply : 48-62 Hz, single phase.

Nominal line	Min./Max. line	Fuse
100 V AC	89 - 108 V AC	1.25 A, Slo-Blo
120 V AC	108 - 130 V AC	1.25 A, Slo-Blo
220 V AC	197 - 238 V AC	0.6 A, Slo-Blo
240 V AC	216 - 260 V AC	0.6 A, Slo-Blo

TABLE 1-8 :
SUMMASIGN PRO T-SERIES ELECTRICAL SPECIFICATIONS

1.3. CUTTER ACCESSORIES AND CONSUMABLES

The following is an overview of the accessories and consumables available for the various SummaSign Pro T-series models:

OPTIONS/ ACCESSORIES/ CONSUMMABLES	T750 Pro	T1010 Pro T1400 Pro
Cutter Stand	Optional 391-400	standard
User's Manual	MD9045	
Power Supply Cables	MC1184 (Europe) MC3545(US)	
Serial Interface Kit, consisting of : - 9 pin to 9 pin cable - 9 pin to 8 pin DIN conv	423-155	
TANGENTIAL knife holder	391-663	
Standard TANGENTIAL knife (1 off)	390-549	
Double tip knife	390-551	
Standard nose piece	391-664	
TANGENTIAL knife for masking stencil (1 off)	390-550	
Nose piece for masking stencil	391-666	
Ballpoint holder	391-667	
Ballpoint pen	391-669	
Holder for drag knife	391-668	
Drag knife (set of 5)	391-360	
2 Flanges for media roll	391-510	
Manual cut-off razor blades (set of 10)	391-146	
Razor blade & holder	391-142	
Pouncing tool	391-981	

TABLE 1-9 :
SUMMASIGN PRO T-SERIES ACCESSORIES AND CONSUMABLES

1.4. REAR PANEL COMPONENTS

In order to get acquainted with your SummaSign Pro cutter, read the following description of the rear panel components. Figure 1-1 shows the location of the main components.

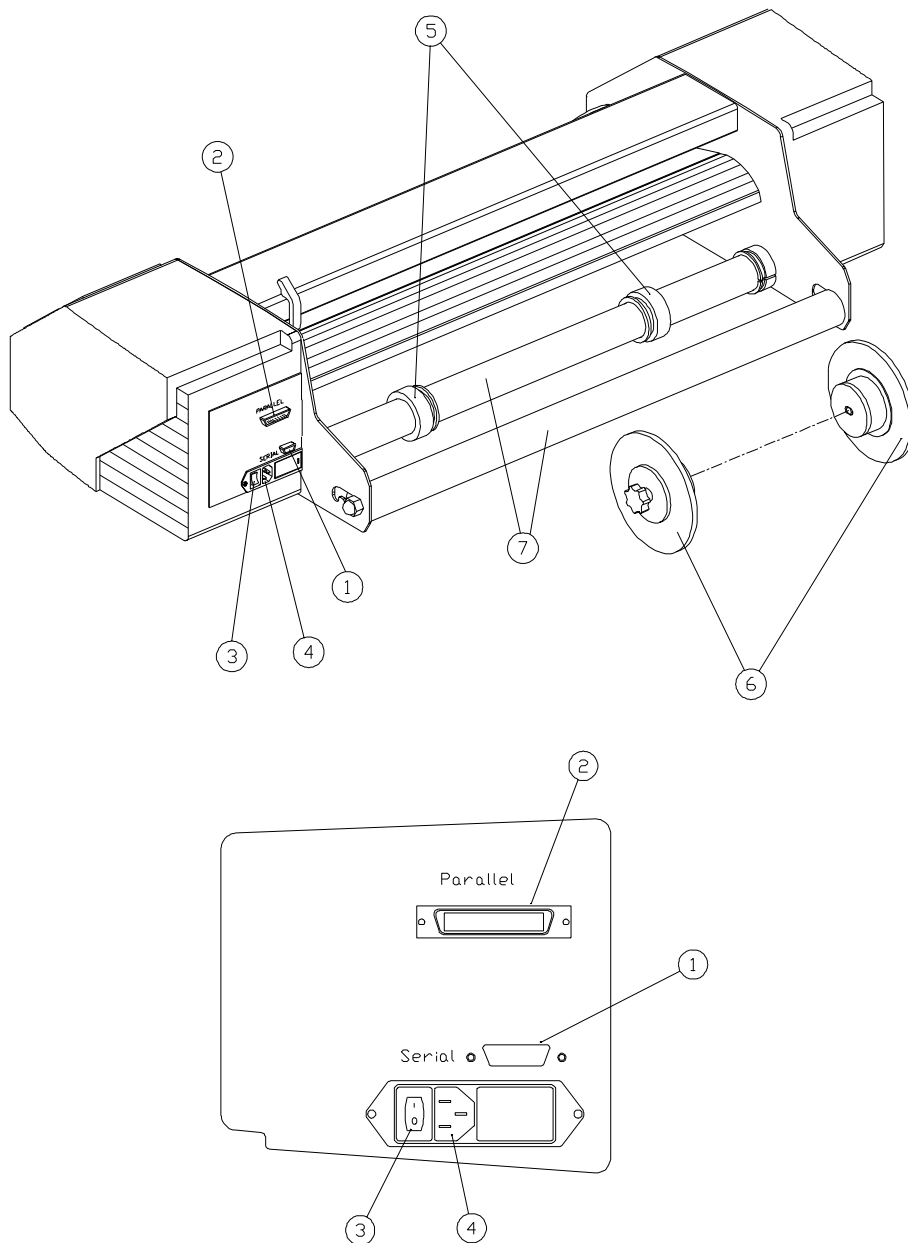

FIGURE 1-1 :
SUMMASIGN PRO T-SERIES CUTTERS, REAR VIEW*

FOR PRACTICAL REASONS, ILLUSTRATIONS RELATE TO THE T750 PRO MODEL. ALL MEMBERS OF THE PRO T-SERIES CUTTERS ARE SIMILAR EXCEPTING IN WIDTH.

1. *RS-232-C Port* : - This DB-9P connector provides the communication link between the cutter and a host computer. It allows bidirectional communication between the host computer and the cutter.
2. *Parallel Port* : - This 36-pin Centronics connector provides a unidirectional communication link between the cutter and a host computer. The cutter can receive but not transmit data via this port.

Note : only one interface can be active at any one time.
The first port that receives data will be the active interface until the cutter is reset.

3. *Power ON/OFF switch* : - This rocker switch sets the cutter's power to ON or OFF. To switch the power ON, press the "I" side of the rocker switch. To switch the power OFF, press the "O" side of the rocker switch.
4. *Power Entry Module* : - The fuse box, the voltage select board and the AC power cord receptacle are located in the power entry module. The power-up procedure is explained in detail in Section 1.6. For information about the conversion of the cutter's operating voltage, see Section 3.2.
5. *Roll Media Guide Bushes* : - The two guide bushes serve to keep the media roll in place when media is pulled from the roll.
6. *Media Flanges* : - The media flanges ensure proper routing of the media roll.
7. *Media Support Roller* : - Rotating support rollers for the media roll.

1.5. FRONT PANEL CONTROLS

In order to get acquainted with your SummaSign Pro cutter, read the following description of the front panel controls and components. Figure 1-2 shows the location of the main components.

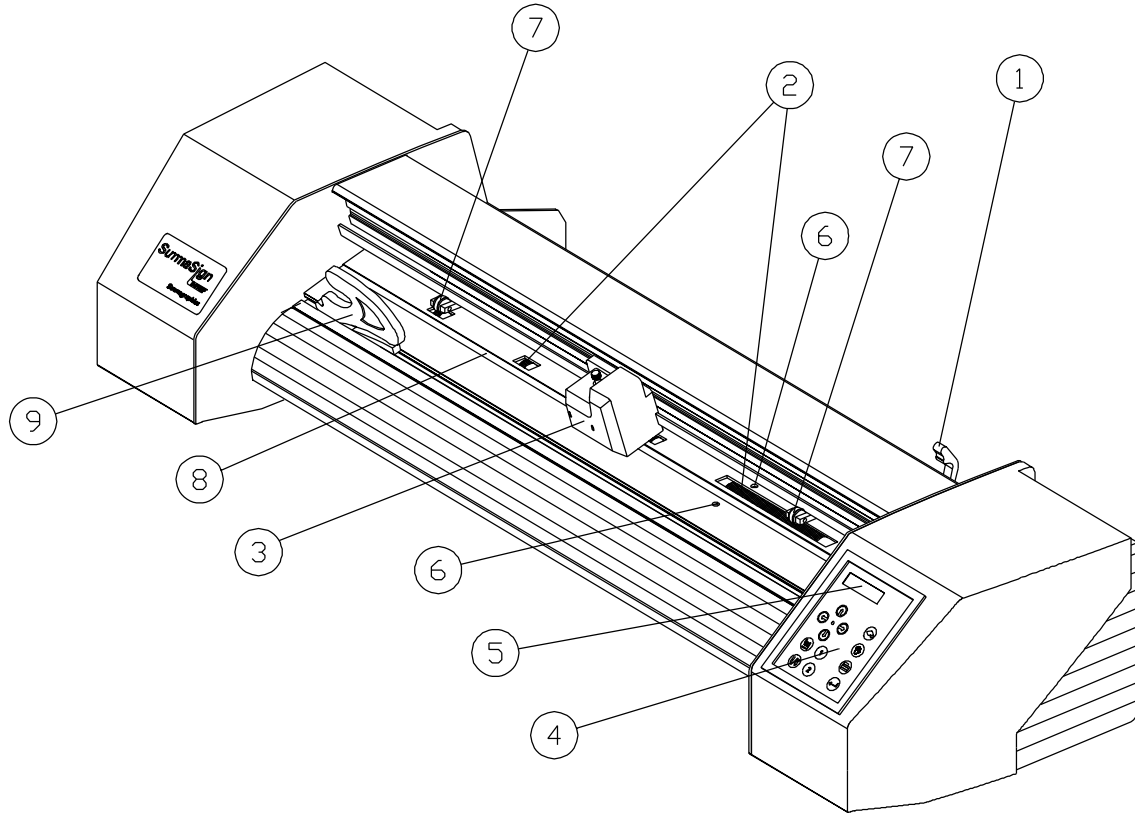



FIGURE 1-2 :
SUMMASIGN PRO T-SERIES CUTTERS, FRONT VIEW

1. *Pinch roller lever arm* : - This lever is used to raise and lower the pinch rollers (Media loading is discussed in Section 1.8).
2. *Media Drive Sleeves* : - The media drive sleeves move the media only when the pinch rollers are in the 'down' position. The following table lists the number of media drive sleeves installed on each model of the Pro T-series cutters.

Number of media drive sleeves	T750 Pro	T1010 Pro	T1400 Pro
Short sleeve	5	6	8
Long sleeve	1	1	1

3. *Tool Carriage* : - The tool carriage is the mount for the tangential cutting head.

4. *Control Panel* : - The control panel contains 12 keys. All cutter activity can be initiated from the control panel. This includes initiating remote mode for computer control, local mode for manual operation and menu mode. Each control panel function is explained in Section 2.1.
5. *Display* : - The 2x16 character display informs the user about the current status of the cutting process or actions which need to be taken.
6. *Sensors* : - The sensors detect the presence of media to avoid any damage to the cutting strip. Upon powering up the machine, they cause the media to move all the way to the front edge of the platen.
7. *Pinch rollers* : - The pinch rollers (one at each side) hold the media clamped between the rubber rollers and the media drive sleeves. The T1010 and T1300 units are provided with an extra low pressure roller in the middle to keep the vinyl media flat.
8. *Cutting strip* : - Soft strip to avoid any damage to the knife tip when no media has been loaded. Since cutting is done on the cutting strip it is essential that the cutting strip remains intact.
9. *Manual cut-off knife* : - Upon completing a sign, move the media forward by pressing the  key. Use the manual knife to cut the finished sign off the media roll. Leave the loaded media in place ready to start your next cut by pressing the  key again.
10. *Stand* : - The stand comes standard with the T1010 and T1400 units. For the T750 unit the stand is optional.

1.6. POWERING UP THE CUTTER

1.6.1. EARTHING



SAFETY WARNING

An insulated earth conductor must be installed as part of the branch circuit which supplies power to the wall outlet to which the cutter is connected. The earth conductor must have the same size, insulation material and thickness as the earthed and unearthed branch-circuit supply conductors, but the insulating sheath should be green, or green with yellow striping.

The earth conductor described above must be earthed at the electrical distribution board, or, if power is supplied by a separate system, at the power supply transformer motor / generator set.

The wall sockets into which the cutter is plugged must be of the earthed type. The earth conductors serving said wall sockets must be properly connected to earth.



CAUTION

Before plugging in the cutter's power cord to a power source, make sure the cutter is set to the correct operating voltage (100 V, 120 V, 220 V, or 240 V AC).
(see section 3.2)

See Table 1-8 for the minimum and maximum operating voltage for the different voltage ratings.

To check the operating voltage setting, locate the power entry module (shown in Figure 1-1) on the cutter's rear panel. The power entry module shows four possible voltage settings (100 V, 120 V, 220 V and 240 V). A pin next to one of the voltage settings indicates the voltage setting currently selected for the cutter. If this setting does not match the voltage supplied to your site, you will have to change the voltage setting prior to powering up the cutter.

For information about the conversion of the cutter's operating voltage and the exact fuse ratings, see Section 3.2.

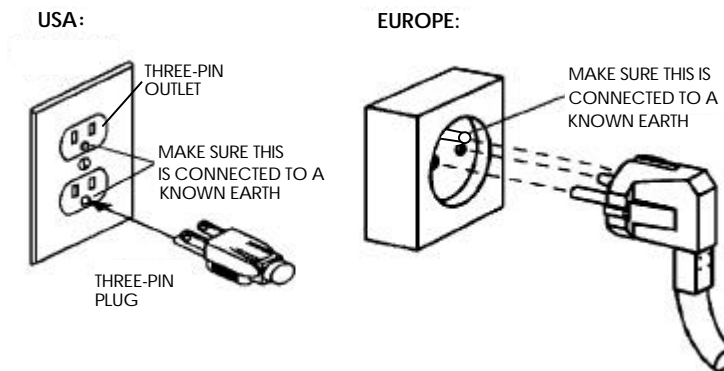



FIGURE 1-3 :
EARTH CONNECTION



IMPORTANT OPERATIONAL TIP

Your cutter must only be used with a power outlet that is properly grounded to earth. Use of an unearthed outlet exposes the operator to risk of electric shock and will also lead to malfunctioning of the cutter.

1.6.2. POWER-UP PROCEDURE

➔ To power up the cutter, proceed as follows:

1. Be sure the cutter is either placed on a flat, level and sturdy surface or securely attached to its (optional) stand .
2. Plug one end of the AC power cord into the AC power cord receptacle on the cutter's rear panel.
3. Plug the other end of the AC power cord into the wall socket.
4. Press the "I" side of the ON/OFF rocker switch on the rear panel to switch the cutter ON.
5. The message "INSERT MEDIA" is displayed on the LCD if no media is loaded and the pinch rollers are in the up position.

1.7. INSTALLATION OF A KNIFE, BALLPOINT PEN OR POUNCING TOOL

1.7.1. INSTALLING A STANDARD TANGENTIAL KNIFE



SAFETY WARNING

Your cutter uses razor-sharp knives. The knife blades may cause serious personal injuries if handled without proper care. Use extreme care when operating the cutter and when installing, removing or handling the knife!

➔ To set up your cutter for TANGENTIAL knife operation, proceed as follows.

1. As shown in Figure 1-4, insert the standard knife blade p/n 390-549 into the knife holder. Make sure the knife blade is firmly fixed into the holder. The knife is firmly fixed when you can not remove it manually from the knife holder.

To remove a fixed blade, when it is too blunt, push against the back of the blade with the tip of a screwdriver. The blade will then jump out of its holder.

This procedure is also valid for the installation of the optional double tip blade p/n 390-551.

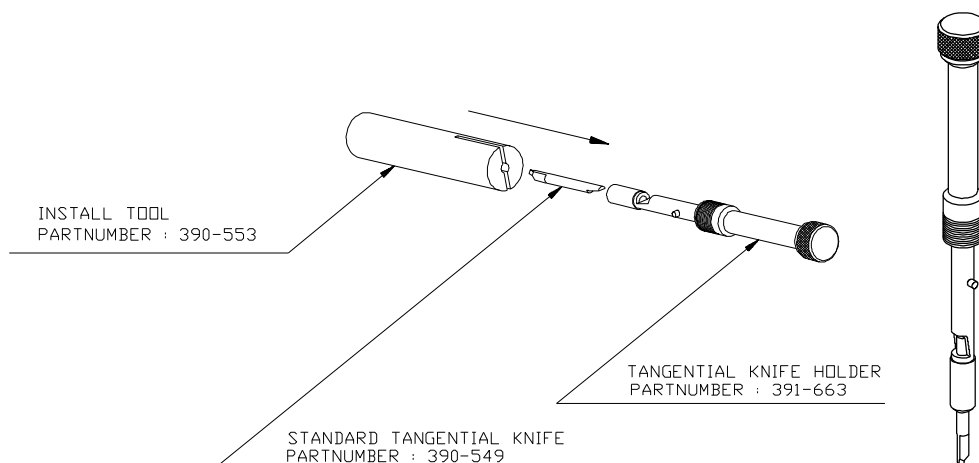

FIGURE 1-4 :
BLADE ASSEMBLY

2. Insert the **grey** nose piece as shown in Figure 1-5 until it snaps into the nose piece holder.

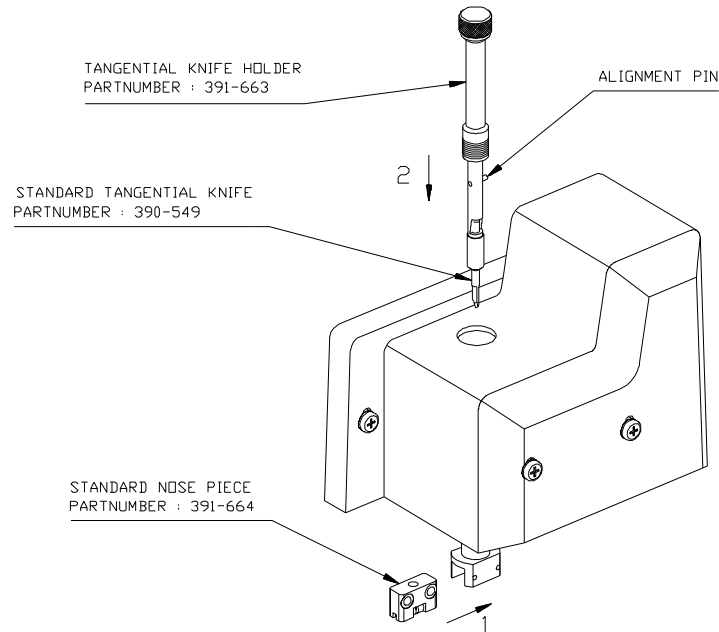

FIGURE 1-5 :
NOSE PIECE INSTALLATION

3. Gently insert the knife into the tool shaft as shown in Figure 1-5. Hold the nose piece in place with one hand, with the other hand turn the knife holder anticlockwise until the alignment pin fits into the small notch of the tool shaft. Now turn clockwise until the knife holder gets grip in the tool shaft.

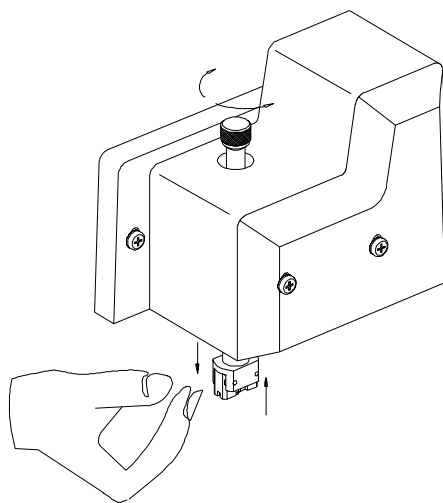

FIGURE 1-6 :
KNIFE HOLDER INSERTION

4. Holding the nose piece in place with one hand, adjust the knife depth with the other hand by turning the knife holder clockwise until the knife tip is just visible from under the nose piece as shown in Figure 1-7.

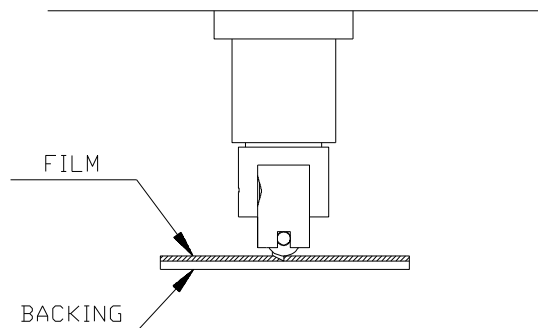



FIGURE 1-7 :
KNIFE DEPTH ADJUSTMENT

5. Set the knife pressure and knife depth as follows :



Load media and power on the cutter.

Press the  key (MENU) key until the message 'USER CONFIG 1' is displayed on the LCD.



Press the  jogging key until the message 'KNIFE PRESS' is displayed.



Press the  or  key to modify the knife pressure.

To increase the cutting depth, turn the knife holder clockwise. To decrease the cutting depth turn the knife holder anticlockwise while holding the nose piece in place with the other hand.

Press the  key to confirm the selection.

Press the **1** key to perform a knife depth test as illustrated in Figure 1-8 .

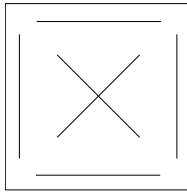

FIGURE 1-8 :
KNIFE DEPTH TEST PATTERN

The knife depth is correctly set when the test pattern is visible on the front side of the media backing, but not on the rear side of the media backing. In general, you should increase the knife depth and knife pressure when using thicker types of vinyl.

NOTE

As the ideal knife pressure and depth setting depends upon the thickness and the type of media to be cut, adjusting the pressure and depth of the knife will require some practice. In general terms, you should increase the pressure and depth of the knife when cutting thicker types of vinyl . For thinner types of vinyl, you will normally have to reduce the knife pressure and depth.



CAUTION

After setting the cutting depth and/or the knife pressure, perform a thorough visual check of the knife blade, which can be seen protruding from the knife holder, and test cutting results on a scrap of vinyl media.

DO NOT OPERATE THE CUTTER if the knife blade cuts through the media backing, as this will seriously damage the cutter's rubber cutting strip and the knife.

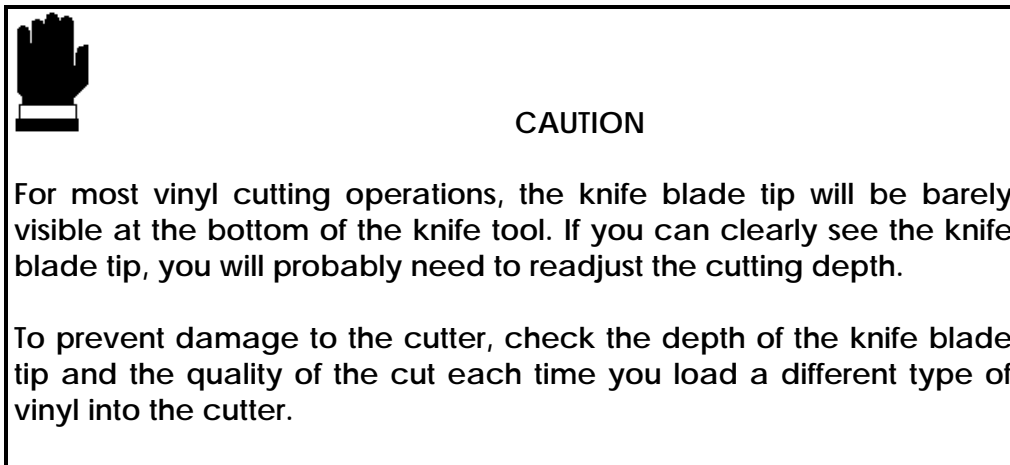

1.7.2 INSTALLING A KNIFE FOR CUTTING MASKING STENCIL OR HEAVY MATERIALS

1. As shown in Figure 1-9, insert the knife blade into the knife holder. Make sure the knife blade is firmly fixed into the holder. The blade is firmly fixed when you can not remove it manually from the knife holder. To remove the blade when it is too blunt, push at the back of the blade with a screwdriver. The blade will jump out of its holder then.

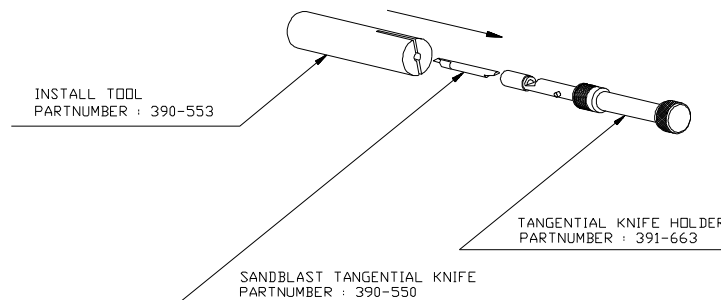

FIGURE 1-9 :
BLADE ASSEMBLY

2. Insert the **black** nose piece as shown in Figure 1-10 until it snaps into the nose piece holder.
When cutting masking stencil always replace the standard nose piece (grey colour) by the masking stencil nose piece (black colour)

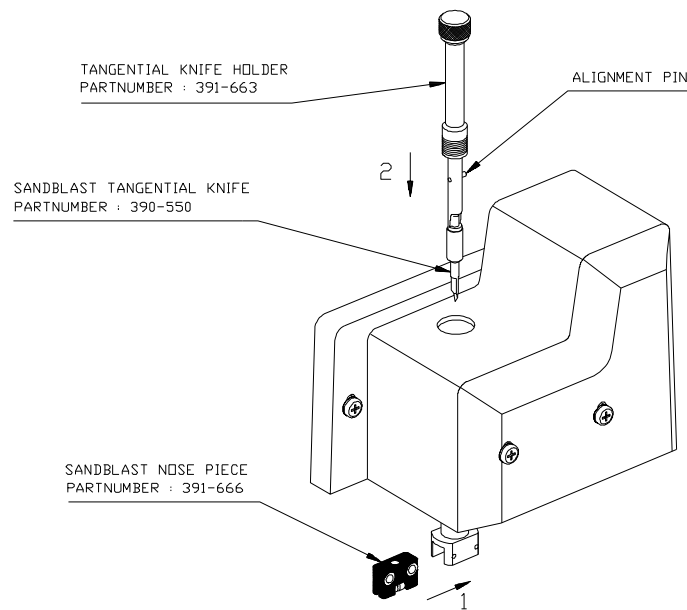

FIGURE 1-10 :
NOSE PIECE AND KNIFE INSTALLATION FOR CUTTING
MASKING STENCILS OR HEAVY MATERIALS

3. Gently insert the knife into the tool shaft as shown in Figure 1-10. Hold the nose piece in place with one hand, with the other hand turn the knife holder anticlockwise until the alignment pin fits into the small notch of the tool shaft. Then turn the knife holder clockwise until it gets grip in the tool shaft.
4. For knife pressure and depth setting, refer to section 1.7.1 point 4 and 5.

NOTE

When cutting masking stencil or heavy materials, it can be necessary to lower the cutting speed of the machine. Very heavy materials should be cut at a speed of 100 mm/s (4 ips) to get no overcurrent error caused by the drive motors. To change the cutting speed, refer to paragraph 2.3.4.

1.7.3. INSTALLING A DRAG KNIFE

The SummaSign Pro T-series cutters can also be operated with a **DRAG** knife. This feature requires a drag knife and drag knife holder.

1. Remove the tangential knife by turning the knife holder anticlockwise with one hand while holding the nose piece in place with the other hand.
2. Insert the drag blade into the drag knife holder as shown in Figure 1-11.

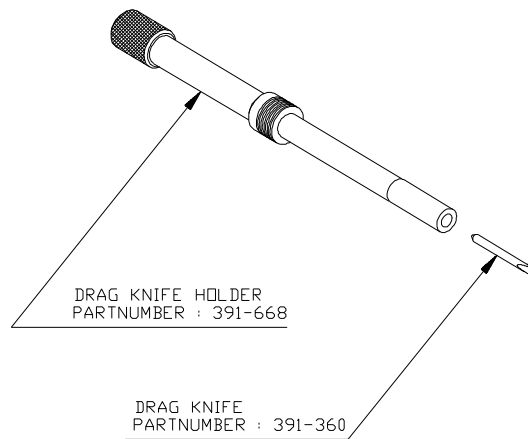

FIGURE 1-11 :
DRAG KNIFE ASSEMBLY

3. Remove the nose piece (refer to Fig 1-12).
4. Insert the drag knife in the tool shaft as shown in Fig 1-12. Turn the drag knife holder clockwise while holding the nose piece holder in place.

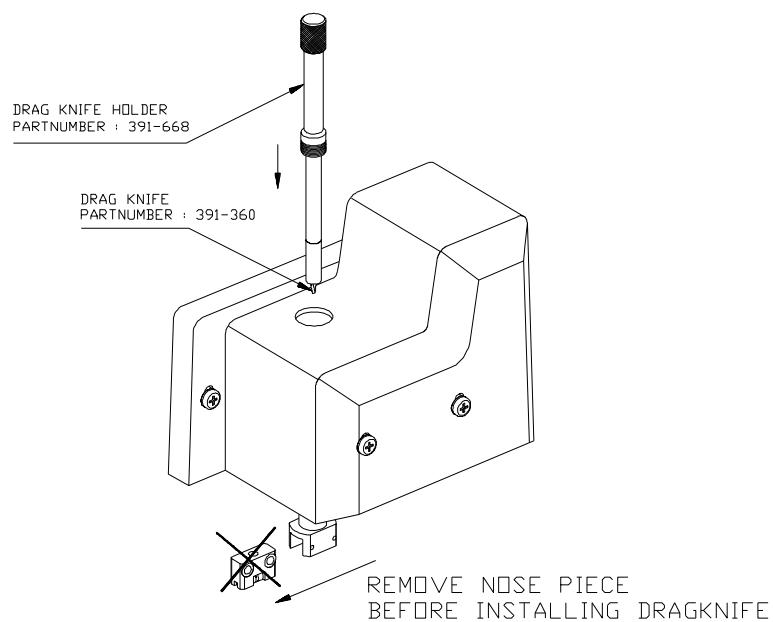



FIGURE 1-12 :
DRAG KNIFE HOLDER INSERTION

5. To configure the cutter for drag knife operation, press the  key (tool select).
Then press the left or right jogging key until DRAG KNIFE appears on the second line of the LCD .
Press ENTER and an asterisk will appear next to DRAG KNIFE. This indicates that the DRAG KNIFE is selected. The drag knife will remain selected until another tool is selected or the cutter is powered down. To start up the cutter in drag knife mode refer to section 2.4.5 (tool submenu of the USER CONFIG MENU).
6. To set the pressure of the drag knife, refer to paragraph 1.7.1 point 5.
7. To set the knife offset, perform the knife offset test described in paragraph 2.3.3.

1.7.4. INSTALLING A BALLPOINT PEN

The SummaSign Pro cutters can also be operated with a **BALL POINT** pen. After replacing the knife with a ball point pen, the cutter can be used as a plotter to draw draft plots of new or existing designs on paper.

➔ To install the ball point pen, proceed as follows:

1. Remove the knife by turning the knife holder anticlockwise with one hand while holding the nose piece in place with the other hand.
2. Remove the nose piece (refer to Fig 1-14)
3. Insert the ballpoint pen holder into the tool shaft as shown in Figure 1-14.

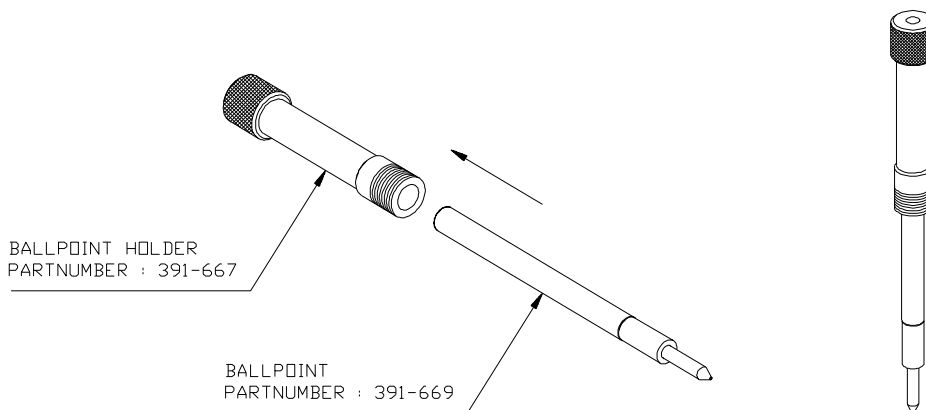

FIGURE 1-13 :
BALLPOINT PEN ASSEMBLY

4. Install the ballpoint pen as shown in Figure 1-14. Insert the ball point pen holder as far as possible by turning it clockwise while holding the nose piece holder in place with the other hand.

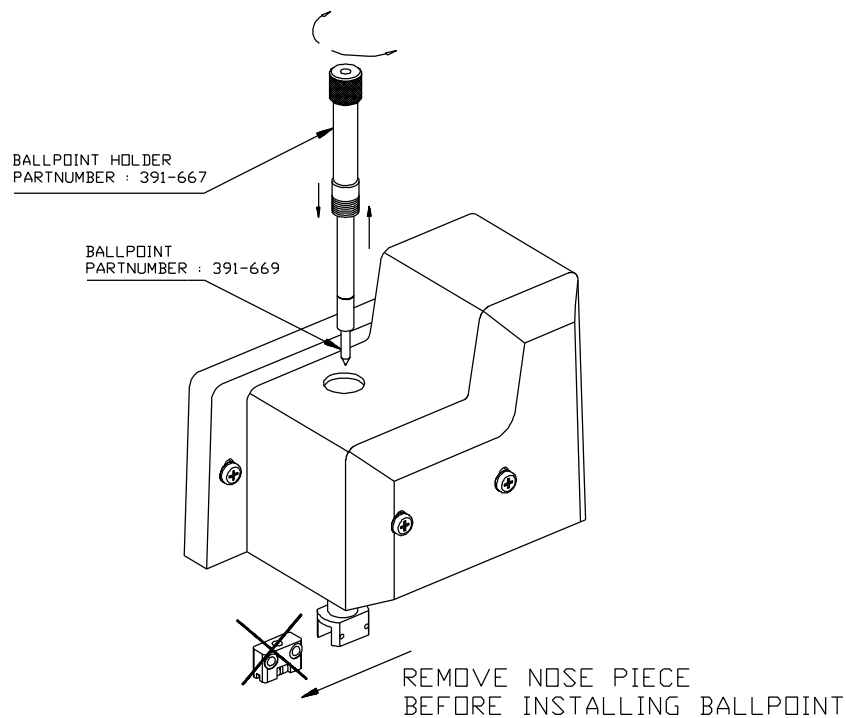



FIGURE 1-14 :
BALLPOINT HOLDER INSERTION

5. To configure the cutter for ballpoint pen operation, press the  key. Press the left or right jogging key until BALLPOINT appears on the second line of the LCD. Press ENTER and an asterisk will appear next to BALLPOINT, this indicates that the ballpoint is selected.

A small P (for "Pen") will be displayed in the upper right corner of the LCD.

1.7.5. INSTALLING A POUNCING TOOL

The SummaSign Pro cutters can also be operated with a **POUNCING TOOL**. After replacing the knife with a pouncing tool, the cutter can be used as a pouncer.

- ➔ To install the pouncing tool, proceed as follows:

1. Remove the knife by turning the knife holder anticlockwise with one hand while holding the nose piece in place with the other hand.
2. Remove the nose piece (refer to Fig 1-14)
3. Insert the pouncing tool into the tool shaft.
4. Insert the pouncing tool as far as possible by turning it clockwise while holding the nose piece holder in place with the other hand.
5. To configure the cutter for pouncing operation, press the  key. Press the left or right jogging key until POUNCER appears on the second line of the LCD . Press ENTER and an asterisk will appear next to POUNCER, this indicates that the pouncing tool is selected.

1.8. LOADING MEDIA

The following procedures are mainly written for using roll media . When using sheets there are two possibilities. Firstly, when using long sheets, roll the sheet up so that the alignment is identical to that of a roll. Secondly, when using short sheets, alignment is not so important. If the sheet is cut off perpendicularly, it can be aligned to the front border.

1.8.1. POSITIONING THE PINCH ROLLERS

When working with cut sheet or roll media, the traction resulting from the contact between the pinch rollers and the drive sleeves moves the media in the X axis (forward/backward).

Proper movement of the media will only occur if the media is driven by the pinch rollers correctly located over two drive sleeves.

The pinch rollers are lowered or raised simultaneously by means of the pinch roller lever arm located on the right hand side of the cutter, next to the control panel. The rollers must be lifted to facilitate vinyl loading when the media is fed from the rear of the cutter to the front.

When in the up position, the pinch rollers can be moved manually to the left or the right along the pinch roller shaft, so that they can be easily positioned in a detent (click position) where they are to be lowered to ensure optimum traction on the media.

When the pinch rollers are in the up position, the message "LOWER CAM ROLLERS" is displayed on the LCD.

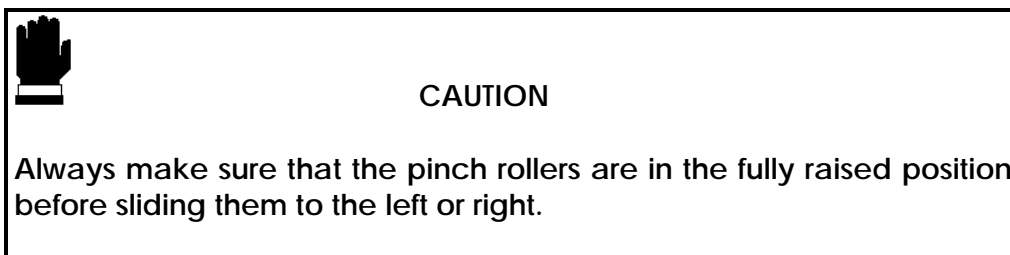

The pinch rollers **MUST** be positioned correctly and lowered onto the media before an automatic load sequence is initiated. Make sure that the two pinch rollers are positioned above the drive sleeves. The left pinch roller should be positioned in a detent (click position). The right pinch roller should be positioned somewhere on the long drive sleeve that only has a click position at the beginning and at the end of the sleeve. The drive drum will move the media only when the pinch rollers are lowered onto the sleeves.

Before lowering the pinch rollers, carefully check the position of the rollers in relation to the drive sleeves. When the pinch rollers are DOWN, the two rollers must run over the sleeves in order to ensure proper media traction. It is very important that both media edges always rest on the sleeves in such a way that the two pinch rollers, which are positioned 3 to 15 mm (0.1" to 0.6") from the media edge, will run over the sleeves when lowered to the drive drum.

On the T1010 and T1400 units, two, three or more sleeves may be partly or fully covered, depending on the media width used. To ensure precise and correct positioning of the pinch rollers, special reference marks have been provided on the head guide.

The central low-pressure roller on the T1010 Pro and T1400 Pro is used to enhance media routing and keep the vinyl flat. Ideally, this roller should be positioned halfway between the two edge rollers and above one of the drive sleeves.

For media widths smaller than 600 mm, the central low-pressure roller on the T1010 and T1400 units can be positioned in the UP position to disable it.

1.8.2. FEEDING AND POSITIONING MEDIA

The loading procedure described below has been found to give excellent repeatability. When loading media, adhere to these step-by-step instructions strictly.

→ To load media, proceed as follows:

1. Raise the pinch rollers by means of the pinch roller lever arm located on the right-hand side of the cutter, next to the control panel.

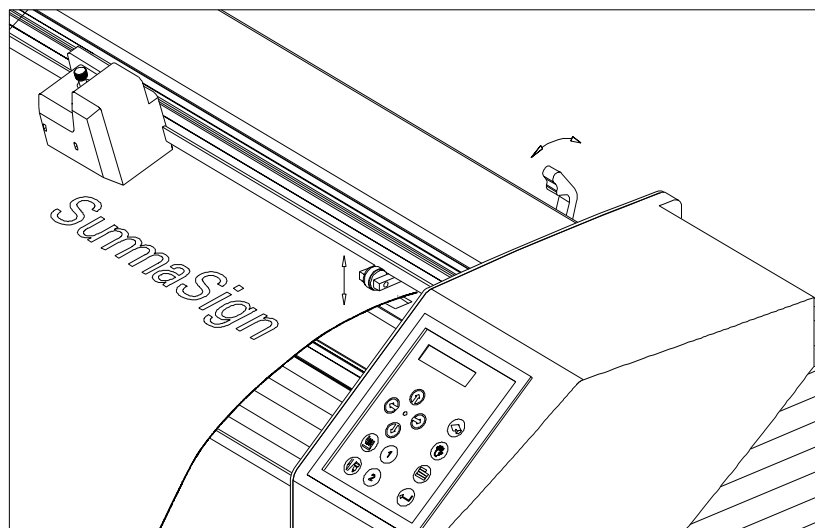

FIGURE 1-15 :
MEDIA POSITIONING

2. When working with roll media proceed by inserting a media flange at each end of the media roll and tighten the thumbscrew until the media roll is firmly gripped between the flanges. Make sure the flanges are firmly pressed against the roll. Place the roll of media on the media support rollers at the rear of the machine.

3. Position the media roll with flanges on the support rollers at the rear of the machine.

Slide the two roll media guide bushes under the media roll so that the roll flanges run into the groove provided in the guide bushes. In this position the media roll and guide bushes can be shifted from the left to the right.

Start feeding the media from the rear of the machine.

Position the left media edge on the left-most drive sleeve and check whether the right media edge is positioned over the long drive sleeve. If so, the left pinch roller can be positioned in a detented position over the left-most sleeve and the right pinch roller is positioned somewhere over the long drive sleeve to suit the media width. The pinch roller can be lowered anywhere between the two detent positions of the long drive sleeve to allow for flexibility in holding any media width.

In circumstances where the above does not work, because your media is too narrow to reach the long drive sleeve, try positioning the left media edge over the second left drive sleeve and position the right media edge somewhere on the long drive sleeve. Repeat this process if the media is found still to be too narrow, locating the left media edge on the third sleeve from the left and adjusting the right hand position as previously described.

Follow the same reasoning when loading media on the wider models of the Pro T-series cutters, which have been provided with more sleeves.

In all cases, both edges of the media have to run over a drive sleeve. If this is not the case, reposition the roll of material to comply with the above.

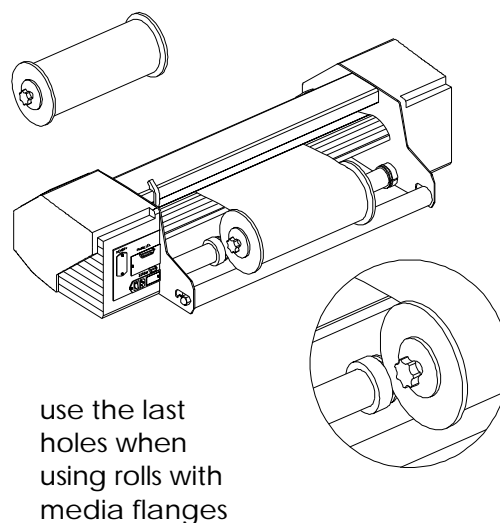
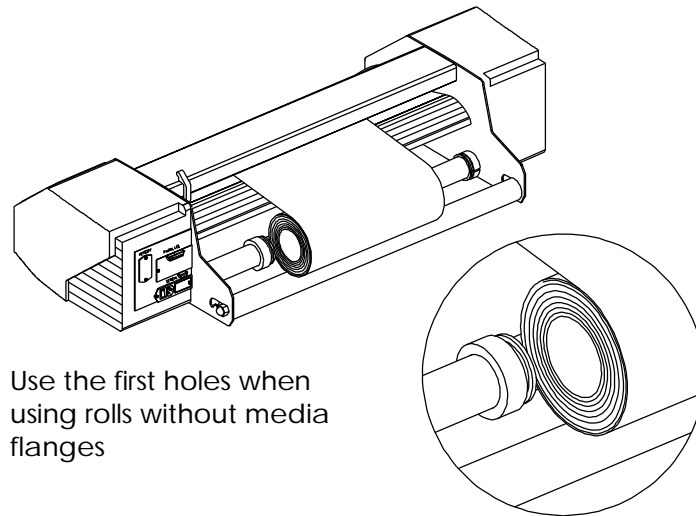

FIGURE 1-16 :
FEEDING ROLL MEDIA USING MEDIA FLANGES



Use the first holes when using rolls without media flanges

FIGURE 1-17 :
FEEDING ROLL MEDIA WITHOUT USING MEDIA FLANGES

4. Make sure that the media follows a straight path from the roll of material. To accomplish this, you can slide the media roll & guide bushes from the left to the right along the media support rollers.
5. The pinch rollers should be positioned over the drive sleeves about 3 to 15 mm (0.1" to 0.6") away from the media's outer edges.

For wide media on the T1010 Pro and T1400 Pro units, slide the central low-pressure roller into position. Ideally, it should be half-way between the two edge rollers and above a drive sleeve.

If the central low-pressure roller does not run over one of the drive sleeves, you may have to turn the knob on the back of the low-pressure roller to disable this roller.

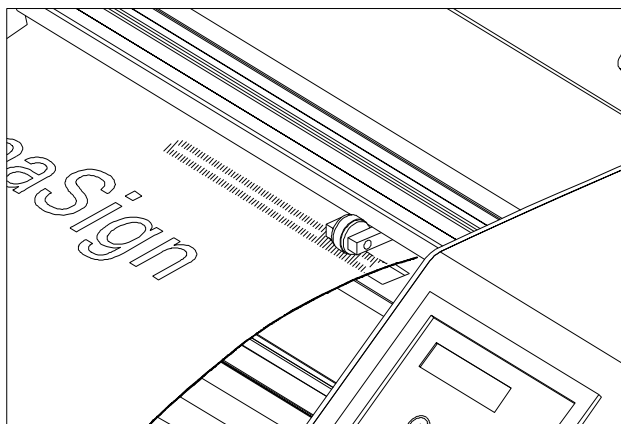

FIGURE 1-18:
PINCH ROLLER POSITIONING

6. Lower the pinch roller lever to press the media firmly against the drive sleeves. After one second the tool carriage automatically moves from the right to the left to sense the usable media width.

NOTE

It is not necessary to unroll the media manually from the roll. The cutter will unroll the media automatically during the load sequence.

7. The positioning and routing of sheet material is identical to that of roll media.
8. The cutter is now ready for the actual load procedure, which may be controlled from the control panel.

1.9 MEDIA LOAD PROCEDURE



SAFE OPERATION

Do not place any objects in front of, or behind, the cutter that could interfere with cutter operation. Make sure the media is free to move back and forth. Keep hands, hair, clothing and jewelry away from moving parts.

Turn the power on and the following message will appear on the LCD screen :

PLEASE WAIT
LOADING...

The cutter will automatically start executing a minimal loading procedure consisting of :

- a media width measurement
- a 45° test
- media is unwound over a length equal to the width measured between the pinch rollers

When the next display appears, the cutter is ready to receive a file :

800mm/s	120 g	K
ONLINE		1

When sending a cut file , the cutter will automatically pull the required media from the roll. The pulling is done in steps such that for each step the length pulled off the roll is identical to the width measured between the pinch rollers.

IMPORTANT

Tracking of longer signs is only guaranteed when you perform the **full load procedure** !

Proceed as follows to complete the full load procedure (recommended for long signs) :

Press the  key and the following message will appear on the LCD screen :

SET ORIGIN

X=0 Y=YYYY ↵

Press the  key again and the following message will appear on the LCD screen :

LOAD

1= ROLL 2= SHEET





Press the **1** key if you want to load media from a **roll**. Press the **2** key if you want to load media in **sheet form**.

If you choose "sheet" and the sensors are enabled, then the sheet is automatically loaded.

If you choose "roll", the following display will appear on the LCD :



SET ORIGIN

X=0 Y=YYYY ↵

Using the , , ,  jogging keys, you can position the knife (i.e. the origin) at any location. Press the  key to confirm the selected point of origin.



MEDIA WINDOW

↑↓ ↵

By pressing the ,  jogging keys, you can enter the length of the media you need for your task.

MEDIA WINDOW

XXXX YYYY ↵

The XXXX-value is the media length you define with the ,  jogging keys. The YYYY-value is the cutting width of the media measured by the cutter. Note : when the media length displayed is zero (0), the default media length will be used.

Press  to confirm the length and the cutter will start "shuffling" the vinyl in order to establish a track on the vinyl.

If you pressed  instead of the jogging keys for defining the media window, the default media length is displayed :

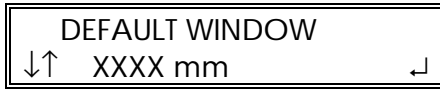

An XXXX-value appears. You can change the default value by pressing the (+10), (-10), (-100), (+100) jogging keys.

Press to confirm the length and the cutter will start shuffling the vinyl in order to set a track on the vinyl.

After shuffling, you get the following display :

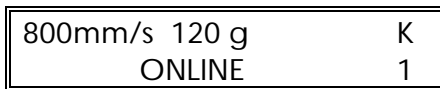

The cutter is now ready to receive a file.

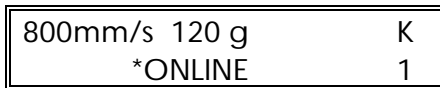

The cutter has been selected by the computer.

When the built-in media sensors detect the end of the roll the message **END OF MEDIA** will be displayed. The display will show the actual length loaded.
 If that area is sufficient, press **1** to **ACCEPT**.
 If not, press **2** to **ABORT** and the media will automatically return to its origin.

CAUTION

When you accept the loaded area in sheet mode, the cutter will clip the sign to be cut in case of insufficient media. Compare the area loaded with the area needed for the sign !

SECTION 2

OPERATION

2.1. THE CONTROL PANEL

Figure 2-1 shows the control panel of the SummaSign Pro T-series cutters. The main functions of the liquid crystal display (LCD) and the control panel keys are explained in the following paragraphs.

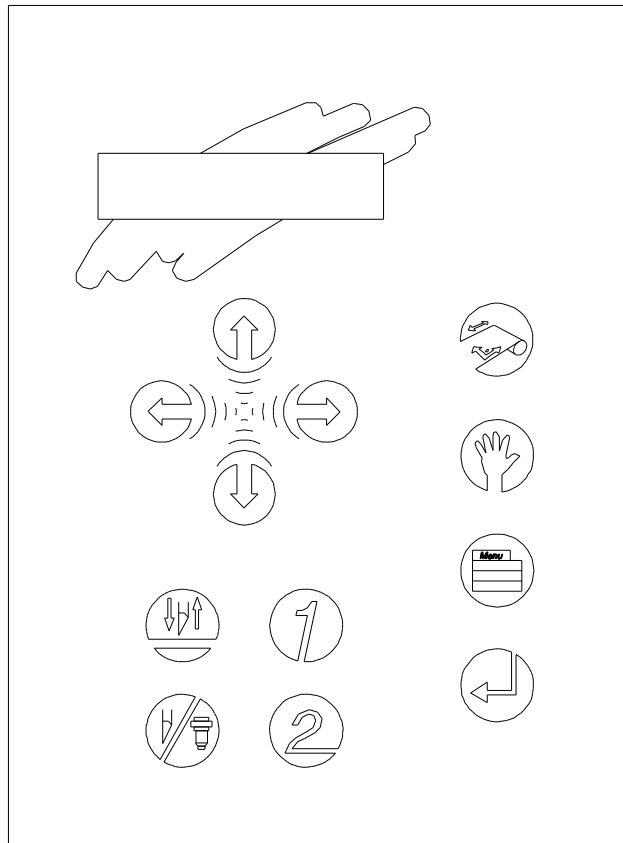







FIGURE 2-1:
SUMMASIGN PRO T-SERIES, CONTROL PANEL

2.1.1. THE LIQUID CRYSTAL DISPLAY

The 32-character liquid crystal display (LCD) contains two lines of 16 characters each. The LCD provides cutter status information during operations and displays menu options for the configuration of the cutter.









The contrast of the LCD can be adjusted from the control panel in order to ensure optimum readability under varying lighting conditions. Instructions for adjusting the LCD contrast are given in Section 2.6.12.

The various menu and submenu items are always presented in a loop, which means that, when the last menu or submenu item is displayed, pressing the appropriate key will automatically take you back to the first item of the same menu or submenu.

Next to the status messages and/or menu options displayed on the LCD, arrow symbols representing the , , ,  jogging keys and  key will tell you what keys to press to go to the next menu item (top line of the display) or to the next value for a given submenu item (bottom line of the display).



2.1.2. THE RESET/LOAD KEY

The  key (RESET/LOAD) is used to move the origin, to initiate a load sequence, to reset the cutter, to abort the cut in progress or to recut the last file. When the  key (RESET/LOAD) is pressed, the cutter goes off line, suspends all operations in progress and displays the RESET/LOAD menu. Press the  key until SET ORIGIN, LOAD, RESET, ABORT or RECUT is displayed. To confirm RESET, ABORT or RECUT press the  key (ENTER). To execute the SET ORIGIN instruction move the knife origin using the , , ,  jogging keys and press the  key (ENTER) to confirm the new origin position. To initiate the LOAD instruction press the 1 or 2 key to initiate a load sequence for a ROLL or SHEET respectively. Upon termination of any of these instructions, the cutter goes on line again.

The SET ORIGIN instruction is used to move the knife origin.

The LOAD instruction is used to initiate a load sequence.

The RESET instruction performs a complete reset of the cutter.



The ABORT instruction simply cancels the cut in progress. Aborting a cut will not reset the cutter parameters: the parameters which had been selected for the cut remain in effect.

The RECUT instruction recuts the last file sent to the cutter (provided that it fitted into the buffer).

When using the MULTIPLE RECUT FUNCTION the different copies will be cut in the media in such a way that there is only a minimal loss of media. The distance between the copies can be changed (See Section 2.4.18).







2.1.3. THE ON LINE KEY

The  key (ON LINE) toggles between on line and off line operation. When the  key is pressed, the selected mode (ON LINE or OFF LINE) is displayed on the LCD.





Selecting OFF LINE will suspend all operations in progress. Pressing the  key while the cutter is off line will make the cutter go on line again, resuming the suspended operation.

While the cutter is off line, the following operations can be performed:

- Press the  or  jogging key to move the tool carriage to the left or right.
- Press the  or  jogging key to make the media move forward (towards you) or backward (away from you). Moving the media forward will prove to be very practical when you require to cut the finished sign off manually.
- Press the  key (TOOL UP/DOWN) to lower or raise the active tool. If the tool is not moved for approximately eight seconds, it is raised automatically.



2.1.4. THE MENU KEY

The  key (MENU) is used to select one of the menus. Pressing the  key will make the cutter go off line and suspend all operations in progress. Pressing the  key repeatedly will display the different menus one by one. As the menu options are on a loop, pressing the  key when the last option is displayed will automatically return you to the first option.

The different menus are illustrated in Figure 2-2.

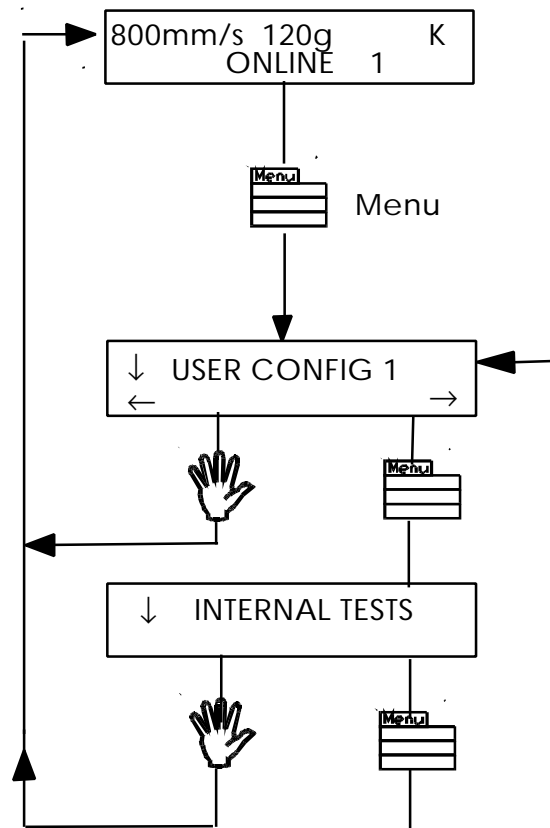







FIGURE 2-2 :
SUMMASIGN PRO T-SERIES CONFIGURATION SUBMENUS

To select a menu by scrolling through the different options, press the  key .

To exit from the menus and resume the previous on line operation, press the  key (ON LINE).

Under normal conditions, the cutter is on line; it may then be selected by the host computer for a cutting or plotting operation or deselected by the host computer. Pressing the ,  or  key will make the cutter go off line, in order to initiate another operation.

The contents of the different menus are summarised in Table 2-1.

MENU	DESCRIPTION
USER CONFIG 1 (->4)	Selects a given active cutter configuration from one of the four sets of configuration parameters stored in the unit' s memory
INTERNAL TEST	Activates one of the resident cutting plots provided for informational purposes.

TABLE 2-1:
CONTENTS OF THE SUMMASIGN PRO T-SERIES MENUS

2.1.5. THE ENTER KEY

The  key (ENTER) is used to select the item currently displayed on the LCD.



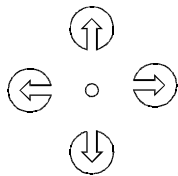

1 2 2.1.6. THE 1 AND 2 KEYS

The use of the 1 and 2 keys varies according to the operation in progress; their use is displayed on the LCD as appropriate.





2.1.7. THE JOGGING KEYS

The use of the jogging keys varies according to the operation in progress.

For example, when working in the USER CONFIG menu, the  or  jogging key is used to select the new user number and the  or  jogging key is used to go to the previous or next menu item.

2.1.8. THE TOOL UP/DOWN KEY





The  key (TOOL UP/DOWN) is used while the cutter is off line to raise or lower the tool. Pressing the  key once will lower the tool onto the media. Pressing the  key again will raise the tool.

If the tool is not moved for approximately eight seconds, it is raised automatically.

 2.1.9. THE TOOL SELECT KEY

The  key (TOOL SELECT) is used to select one of the following tools :

- a tangential knife
- a drag knife
- a ballpoint pen
- a pouncing tool

To temporarily change the tool, press the  key, then press the  or  jogging key until the desired tool appears on the second line o the LCD. Press the  key to confirm the tool. An asterisk * appears next to the selected tool. When the cutter is powered on the next time, the default tool will be selected. For setting up the default tool see Section 2.4.5.

2.2. NORMAL OPERATION

The term "normal operation" covers on line operation, off line operation and local operation, i.e. the three types of operation for actual cutting or plotting. They are explained in further detail in the following paragraphs.

2.2.1. ON LINE AND OFF LINE

On line and off line are two important concepts when using the SummaSign Pro cutters. The cutter is on line only when the following message is displayed on the LCD :

800mm/s	120 g	K
.45mm(1)	ON LINE	1

This display message should be read as follows :

800 mm/s	=	velocity
120 g	=	knife pressure, pen pressure or pouncing pressure
K	=	knife operation (K) or pen operation (P)
.45 mm(1)	=	knife offset - only displayed when in drag knife mode
ON LINE	=	cutter is ready to receive data
1	=	user number

In all other cases, the cutter is off line.

When on line, the cutter can be addressed by the host computer, which means that the cutter will execute cutting or plotting instructions issued by the host computer' s application software. The host computer will first issue a SELECT sequence to the on line cutter, and the message "*ON LINE" will be displayed on the LCD. The asterisk indicates that the host is in communication with the cutter : i.e. the cutter is now "selected" by the computer.

When the cutter is on line and ready to receive instructions from the host computer, it will remain deselected until actual instructions from the computer are received. When the cutter is on line, but has not been selected by the host computer, the message "ON LINE" is displayed on the LCD, without the asterisk.

For normal cutting operations, the cutter **MUST** be on line, so that it can receive instructions from the host computer and the cutting/plotting software.

When the cutter is on line, but has not been selected by the host computer, the following conditions must be met:







- The cutter must be powered ON.
- Media must be loaded. For detailed media loading instructions, see Section 1.8 .
- The proper tool must be installed.
- The cutter must be connected to the host computer via a RS-232-C link or a parallel interface.
- The cutter must be configured for the scheduled operation.

To put the cutter off line, press the ,  or  key. Pressing any of these keys will suspend the current cutting/plotting operation until the cutter is put on line again.

2.2.2. LOCAL OPERATION

Local operation is only possible while the cutter is off line. Local operation means that the cutter is operated directly by the operator via instructions entered on the control panel.

➔ To work in local operation mode, proceed as follows:



1. If the cutter is still on line, press the  key once to select off line. The media will move forward over a certain distance.
2. To move the carriage to the left or right, press the  or  jogging key.
3. To make the media move forwards (towards you) or backwards (away from you), press the  or  jogging key.
4. To move the tool head up or down, press the  key.
5. To end local mode and put the cutter on line again, press the  key.

2.3. THE USER CONFIG MENU

The USER CONFIG(uration) menu gives access to different submenus which allow you to configure the cutter' s operating parameters. It should be taken into account that access to some of the submenus will be determined by the plotting language you are using.

Four different user configurations can be saved. The selected configuration number is displayed on the LCD next to the USER CONFIG message. These four USER CONFIG 1(->4) menus are maintained independently.

➔ To select another **configuration number**, proceed as follows:







1. Power on the cutter.
2. Press the  key until USER CONFIG 1(->4) is displayed.
3. Press the  or  jogging key until the desired configuration number is displayed next to USER CONFIG.

NOTE

Before altering any of the items in the USER CONFIG menu, make sure that you have previously selected the right configuration number in the USER CONFIG 1(->4) menu.

Figure 2-3 shows the USER CONFIG submenus.

➔ To select and alter a configuration parameter, proceed as follows:

1. Power on the cutter.
2. Press the  key until USER CONFIG 1(->4) is displayed.
3. Press the  or  jogging key until the desired submenu is displayed on the first line of the LCD.
4. Press the  or  jogging key until the desired value is displayed on the second line.
5. Press the  key to confirm the selection, an * will be displayed next to the selected setting. (An * is always displayed next to the active value.)

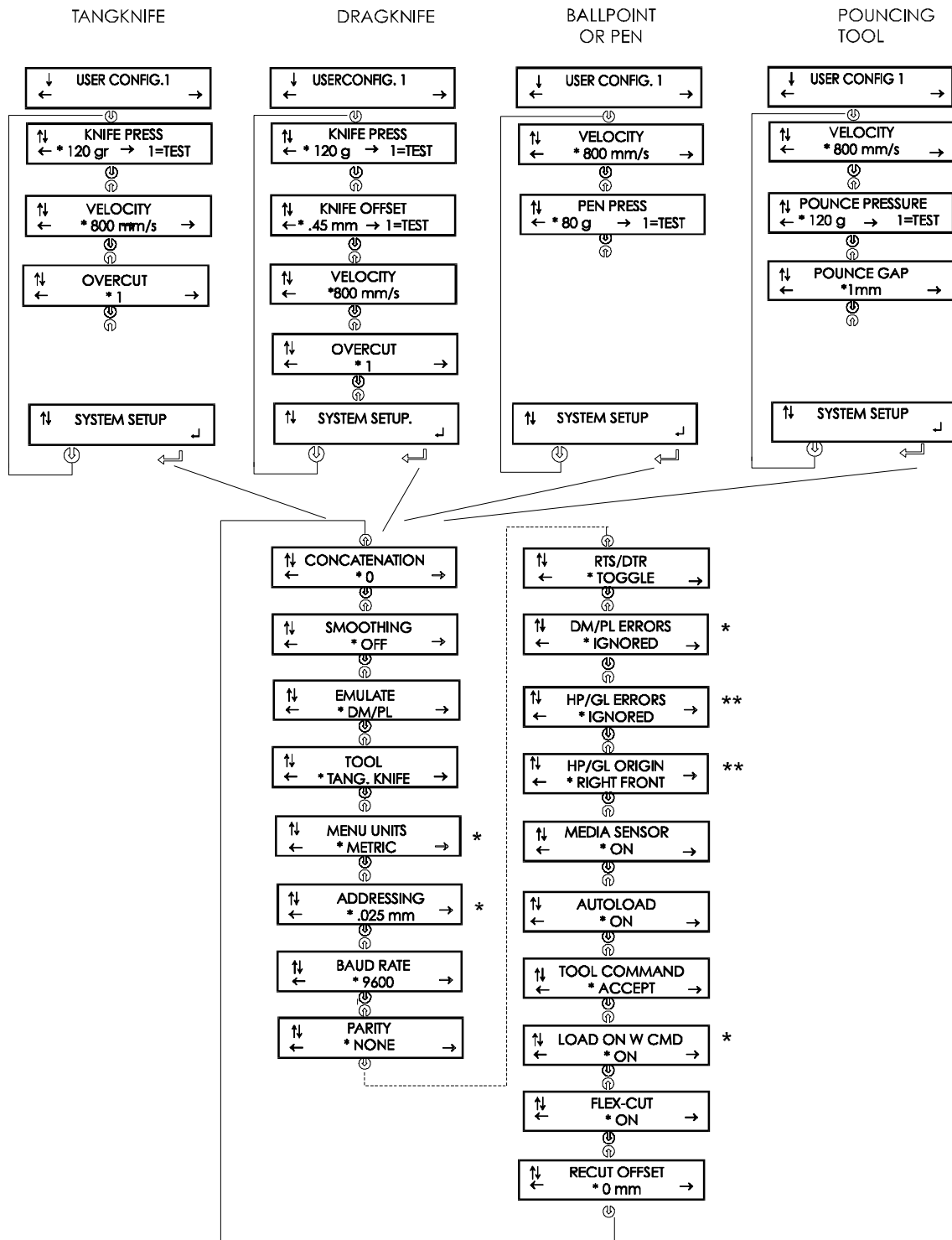

* = IN DM/PL ONLY
 ** = IN HP/GL AND HP/GL/2 ONLY

FIGURE 2-3 :
 FLOWCHART SHOWING FACTORY PRESET MENU SETTINGS

2.3.1. KNIFE PRESSURE

The KNIFE PRESSURE submenu is used to set or modify the cutting pressure of the knife.

The default knife pressure value is 120 grams.

The knife pressure can be set between 0 and 600 grams.

The knife pressure value is set in 5 gram increments.

On the LCD, the active knife pressure value is marked with an *.

Knife pressure setup is explained in detail in section 1.7.1.

2.3.2. PEN PRESSURE

The PEN PRESSURE submenu is used to set or modify the pressure of the ball point pen.

The default ball point pressure value is 80 grams.

The pressure can be set between 0 and 600 grams in 5 gram increments.

On the LCD, the active pen pressure value is marked with an *.

2.3.3. POUNCING PRESSURE

The POUNCING PRESSURE submenu is used to set or modify the pressure of the pouncing tool.

The default pouncing pressure value is 120 grams.

The pressure can be set between 0 and 600 grams in 5 gram increments.

On the LCD, the active pouncing pressure value is marked with an *.

2.3.4. KNIFE OFFSET

The KNIFE OFFSET submenu is used to set or modify the distance between the **DRAG** knife blade tip and the centre axis. This routine applies to a **drag knife only**.

The default drag knife offset value is .45 mm.

The value can be set between 0 and 1 mm.

Make sure that the selected knife offset value matches that of the knife. Some fine tuning may be necessary because of the mechanical tolerances on the knife. To verify the knife offset, a test can be cut by pressing the 1 key.

If the offset value is set too low, the rectangles will not close.

When the offset value is set too high, the rectangles will be distorted.

The offset test is illustrated below.

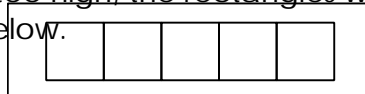

2.3.5. POUNCING GAP

The pouncing gap submenu is used to set or modify the distance between the pounced wholes. This routine applies to the pouncer only.

The default pouncing gap value is 0 mm.

The value can be set between 0 and 50 mm.

On the LCD, the active pouncing gap value is marked with an *.

2.3.6. VELOCITY

The VELOCITY submenu is used to set or modify the velocity of the tool.

The default velocity is 800 mm/s (32 ips).

The velocity can be set between 50 mm/s (2 ips) and 1000 mm/s (40 ips).

2.3.7. OVERCUT

The OVERCUT submenu enables you to generate an overcut in order to facilitate weeding the cut.

The default overcut is set to 1.

The overcut setting can be disabled (=0) or set to any value between 0(=off) and 10. One unit is about 0.1 mm or 0.004".

On the LCD, the active value is marked with an *.

2.3.8. SYSTEM SETUP

The SYSTEM SETUP submenu covers the menu items you normally only need when establishing the initial setup e.g. when you install the cutter in combination with the software you use.

Press the  key to access the different submenu items, which are explained in section 2.4.

2.4 SYSTEM SET UP

Refer to Figure 2-3.

2.4.1. CONCATENATION

The CONCATENATION feature increases the speed and quality with which cut data having a very high resolution is cut. However when changing over to normal characters again, deactivate concatenation by setting this parameter to 0.

On the LCD, the active concatenation value is marked with an *.

2.4.2. SMOOTHING

The SMOOTHING feature helps to cut smoother curves when curve data with many short vectors is received from the computer.

The default setting is OFF.

On the LCD, the active setting is marked with an *.

2.4.3. EMULATE

The EMULATE submenu is used to select the active cutting/plotting language for the cutter.

The SummaSign Pro cutters support DM/PL , HP/GL and HP/GL/2.

On the LCD, the active plotting language setting is marked with an *.

NOTE

The active cutting/plotting language MUST match the cutting software.

Always select a language which is supported by the host computer' s cutting software.

Whenever possible, select the DM/PL menu option to set the active cutting/plotting language to Houston Instrument Digital Microprocessor/Plotting Language (DM/PL). This selection will allow the cutter to operate with DM/PL-based cutting / plotting software. This language, having special command extensions for cutting, normally gives superior cutting performance.

Select the HP/GL menu option to set the active cutting/plotting language to HP/GL. The cutter will emulate an HP model 758xB plotter (with selectable origin, see 2.4.12).

2.4.4. TOOL

The TOOL submenu is used to select the default tool at power up.

To configure the cutter for TANGENTIAL KNIFE cutting operations, select the TANG. KNIFE option.

To configure the cutter for PLOTTING operations, select the BALL POINT option.

To configure the cutter for DRAG KNIFE cutting operations, select the DRAG KNIFE option.

To configure the cutter for POUNCING operations, select the POUNCING TOOL option.

To select a tool other than the default one temporarily, see section 2.1.9.

2.4.5. MENU UNITS

The MENU UNITS submenu allows you to select English or metric menu units for DM/PL. In HP/GL & HP/GL/2 the menu units are always in metric.

For models sold in the US, English units are the default setting.

For models sold in Europe, metric units are the default setting.

On the LCD, the active menu units setting is marked with an *.

2.4.6. ADDRESSING

The ADDRESSING submenu is used to select the cutter' s default DM/PL user-addressable resolution. In HP/GL & HP/GL/2 the addressing is fixed at 0.025 mm.

The default addressing resolution is 0.025 mm (Europe) or 0.001" (US).

The user-addressable resolution can be set to 0.025 mm or 0.001" or 0.1 mm or 0.005".

On the LCD, the active resolution value is marked with an *

2.4.7. BAUD RATE

The BAUD RATE submenu is used to set or modify the operating baud rate for RS-232-C serial communications between your cutter and the host computer.

The default baud rate is 9600 bps.

The baud rate can be set to any of the following values: 2400 bps, 4800 bps, 9600 bps, 19200 and 38400 bps.

On the LCD, the active baud rate value is marked with an *.

NOTE

The baud rate setting of your cutter MUST match the host computer' s baud rate setting.

2.4.8. PARITY

The PARITY submenu is used to set or modify the byte format and parity type for RS-232-C serial communications between your cutter and the host computer.

The default parity setting is bit 8 = 0 (8 data bits, no parity, the 8th bit being a low bit). The parity can be set to any of the following values:

LCD information	Parity setting	Remarks
BIT 8 = 0	8 data bits, no parity	bit 8 = low (0)
BIT 8 = 1	8 data bits, no parity	bit 8 = high (1)
EVEN	7 data bits, 1 parity bit	parity bit = even
ODD	7 data bits, 1 parity bit	parity bit = odd

On the LCD, the active parity setting is marked with an *.

NOTE

The parity setting of your cutter MUST match the host computer' s parity setting.

2.4.9. RTS/DTR

The RTS/DTR submenu controls the Request To Send (RTS) and Data Terminal Ready (DTR) signals of the cutter' s RS-232-C serial communications interface for hardware handshaking.

The RTS/DTR default value is TOGGLE.

RTS/DTR can be set to TOGGLE (hardware handshaking) or HIGH (software handshaking).

On the LCD, the active handshaking setting is marked with an *.

2.4.10. DM/PL ERRORS

The DM/PL ERRORS submenu is used to determine whether or not different DM/PL errors, such as illegal plot commands, invalid parameter ranges or communication errors, will be displayed on the LCD. This menu will only be displayed if PLOT LANGUAGE is set to DM/PL.

The DM/PL ERRORS submenu can be set to REPORTED or IGNORED.

On the LCD, the active setting is marked with an *.

The feature is activated by selecting REPORTED. It is normally used only when attempting to debug a communication link between the cutter and the host computer.

After the communication link has been debugged, select IGNORED to disable the feature.

2.4.11. HP/GL ERRORS

The HP/GL ERRORS submenu is used to determine whether or not different HP/GL errors, such as illegal plot commands, invalid parameter ranges or communication errors, will be displayed on the LCD. This menu will only be displayed if PLOT LANGUAGE is set to HP/GL.

The HP/GL ERRORS submenu can be set to REPORTED or IGNORED.

On the LCD, the active setting is marked with an *.

The feature is activated by selecting REPORTED. It is normally used only when attempting to debug a communication link between the cutter and the host computer.

After the communication link has been debugged, select IGNORED to disable the feature.

2.4.12. HP/GL ORIGIN

The HP/GL ORIGIN submenu will only be displayed if the PLOT LANGUAGE is set to HP/GL. (See Paragraph 2.4.4.) The HP/GL ORIGIN submenu is used to set the origin in the centre (see HP/GL 758x) or the bottom-right corner (see HP/GL 7475) of the loaded media.

The HP/GL ORIGIN option can be set to RIGHT_FRONT or CENTRE.

On the LCD, the active setting is marked with an *.

If the cut is found to be incomplete, and is wholly located in the upper left corner of the media then modify the HP/GL ORIGIN setting to RIGHT FRONT. If the cut is found to be incomplete, and is wholly located in the lower right corner of the media then change the HP/GL ORIGIN setting to CENTRE.

2.4.13. MEDIA SENSOR

The MEDIA SENSOR submenu is used to activate or deactivate the media sensors. On the LCD, the active setting is marked with an *.

The sensors detect whether media is loaded or detect the end of media. The sensors prevent damage to the cutting strip and knife tip.

2.4.14. AUTOLOAD

The AUTOLOAD option enables the user to the change the vinyl unroll proceedings. When AUTOLOAD is ON , the cutter will automatically unroll the vinyl when needed. When the AUTOLOAD option is OFF, the operator himself should unroll enough media before starting to cut.

The default setting is ON. The best results and performance are guaranteed when using this setting. On the LCD display, the active setting is marked with an *.

2.4.15. TOOL COMMAND

The TOOL COMMAND is used to determine whether the DM/PL and HP/GL pen/knife-select commands (the P and SP commands respectively) are ignored or accepted.

When the TOOL COMMAND option is set to "ACCEPT", the P or SP commands will change the selected tool in the cutter according to the suffix that follows the pen/knife command. The cutter' s LCD will, e.g. prompt the user with the following message: "INSERT PEN" when a P2 command is sent. When the TOOL COMMAND option is set to "IGNORE", the pen/knife commands are ignored. On the LCD, the active setting is marked with an *. The default setting is "ACCEPT".

2.4.16. LOAD ON W COMMAND

The LOAD ON W CMD submenu will only be displayed if the PLOT LANGUAGE is set to DM/PL (See Paragraph 2.4.4.). The LOAD ON W CMD determines, when receiving the DM/PL Window-command (W-command), whether aside from the scaling function, media is loaded or not. Besides scaling, the W-command is also very useful when cutting long signs. With the W-command, media loading will go smoother. Sufficient media will be pulled off the roll at once. Even when AUTOLOAD is off, there is no need anymore to unroll the media manually.

2.4.17. FLEX-CUT

FLEX-CUT can be set to OFF, to Mode 1 or Mode 2. When the cutter is set to mode 1 or mode 2, it will alternately cut one length with full pressure, and one length with reduced pressure. The feature FLEX-CUT offers the advantage that it cuts completely through the material, yet allowing the material to stay together by means of the small media bridges.

MODE 1 is the quickest mode, but it is less precise because the pressure changes during the cutting. MODE 2 is a lot slower, but at the same time it is much more precise, as the cutter stops at every change of pressure. Pressing the **1** key will activate the configuration menu, which allows you to set the cutting pressure and the cut length.

1. CUT LENGTH

This parameter determines the length that is cut with full pressure. By pressing the **1** key, the FLEX-CUT test pattern will be cut.

2. FLEX-CUT LENGTH

This parameter determines the length that will be cut with reduced pressure or without pressure. By pressing the **1** key, the FLEX-CUT pattern will be cut.

3. FLEX PRESSURE

This parameter determines the pressure of the FLEX-CUT LENGTH. By pressing the **1** key, the FLEX-CUT test pattern is cut.

2.4.18. RECUT OFFSET

The recut offset submenu is used to set or modify the distances between the drawings when making multiple recuts.





The default recut offset value is 0 mm.

The distance can be set between 0 and 255 mm.

On the LCD, the active recut offset value is marked with an *.

2.5 INTERNAL TEST MENU

➔ To access any internal test, proceed as follows:

1. Power the cutter on.
2. Load cutting or plotting media.
3. Install a knife or a pen.
4. Press the  key until INTERNAL TEST is displayed and press the  jogging key.
5. Press the  or  jogging key until the desired internal test is displayed.
6. To perform the test, press the  key.

To exit from this menu and go to another menu, press the  key until the desired menu is displayed.

To exit from the menus and put the cutter on line again, press the  key.

Figure 2-4 shows the different INTERNAL TEST submenus.

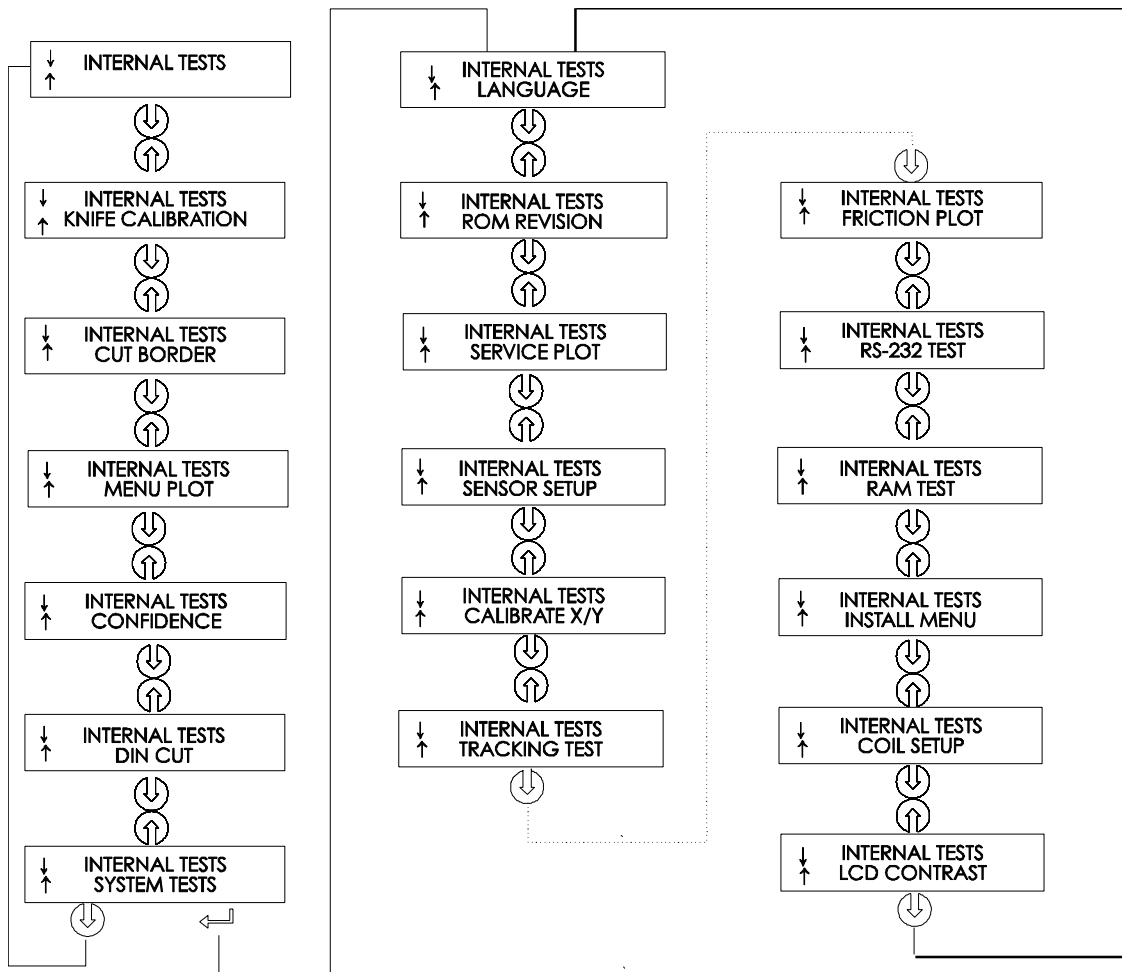

FIGURE 2-4 :
INTERNAL TESTS SUBMENU

2.5.1. TANG. KNIFE CALIBRATION

The purpose of the knife calibration routine is to detect and, if need be, to correct problems related with the concentricity of the TANGENTIAL knife blade. This routine should only be run when required. When noticing cut quality problems with a new knife, perform a knife calibration test as described in the following paragraphs.

During the knife calibration routine, the cutter will cut a series of test patterns which will allow you to identify errors in knife rotation and concentricity. Corrective measures can be taken using the control panel keys.

Knife calibration errors may be due to any of the following causes (see Fig. 2-5):

- **Concentricity misalignment.** The knife tip is slightly rotated in relation to its theoretical 0° angle. This error can be corrected by means of the ADJUST ORIGIN test routine.
- **Horizontal misalignment.** The knife tip deviates from its theoretical longitudinal centre. This error can be corrected by means of the ADJUST LONG. test routine.
- **Vertical misalignment.** The knife tip deviates from its theoretical lateral centre. This error can be corrected by means of the ADJUST LAT. test routine.

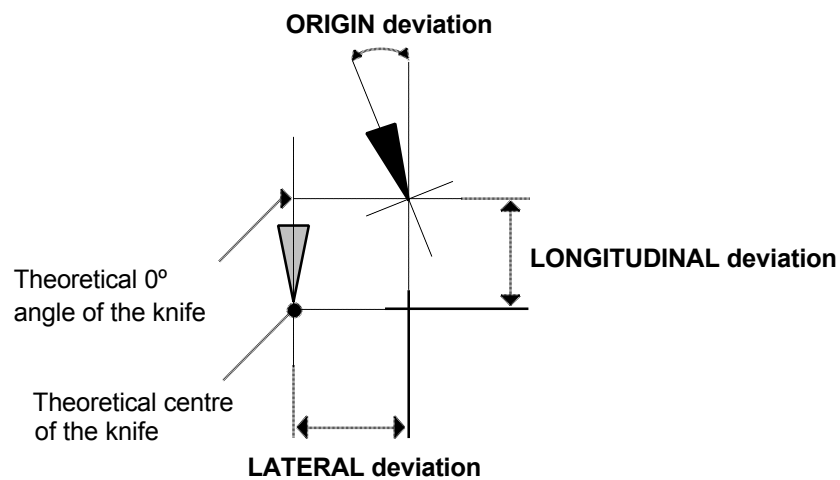

FIGURE 2-5:
POSSIBLE KNIFE CALIBRATION GROUNDS

The calibration settings entered during the knife calibration routine are automatically stored in the cutter' s memory and will be maintained after power down.

NOTE

Prior to knife calibration, load vinyl and install a knife to avoid damage to the cutting strip.

2.5.1.1. ADJUST ORIGIN test routine

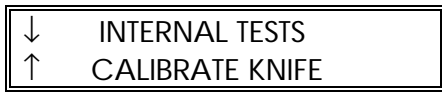

Press to select the ORIGIN test.



Press to execute the ORIGIN test.

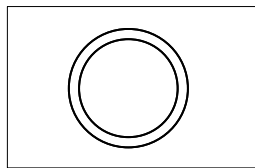

This is the correctly cut test pattern.

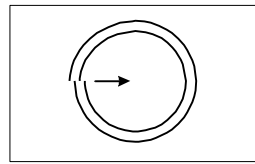

Weed out the ring and compare the circle pattern cut in the vinyl with the circle pattern illustrated above. If you obtained this kind of pattern, increase the value displayed on the LCD by pressing the jogging key to correct closing of the circles cut. To repeat the test, press the key.

Press the key to go to the next step of the calibration procedure

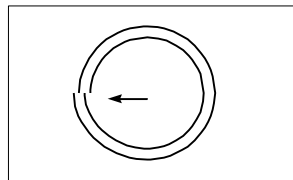

However if you obtained the kind of pattern illustrated above, then, decrease the value displayed on the LCD by pressing the jogging key to correct closing of the circles cut.

To repeat the test, press the key.

Press the key to go to the next step of the calibration procedure

2.5.1.2. ADJUST LAT. test routine



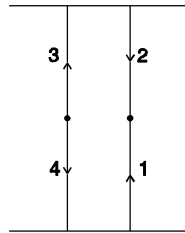

Press  to execute the LAT test.



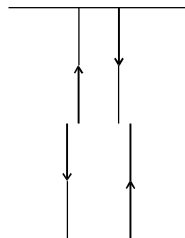

- 1 runs from the horizontal line at the bottom to the centre.
- 2 runs from the horizontal line at the top to the centre.
- 3 runs from the centre to the horizontal line at the top.
- 4 runs from the centre to the horizontal line at the bottom.

Carefully check the alignment of the different cuts: the two vertical lines should meet seamlessly precisely in the middle, without any gaps.





Weed out the rectangle and if you obtained the kind of pattern illustrated above, decrease the value displayed on the LCD by pressing the  jogging key to correct closing of the lines cut.

To repeat the test, press the  key.

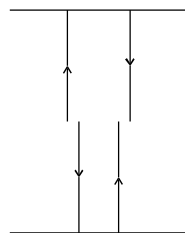
Press the  key to go to the next step of the procedure.



However, in case your cut resembles the pattern illustrated above, increase the value displayed on the LCD by pressing the  jogging key to correct closing of the lines cut.

To repeat the test, press the  key.

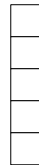

A complementary test has been added to fine tune the LAT. adjustment. Press the 2 key to perform the vertical test shown above. All the squares should be identical.

Press the  key to go to the next step of the procedure.

2.5.1.3. ADJUST LONG. test routine



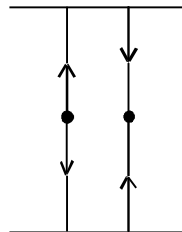

Press  to execute the LONG test.



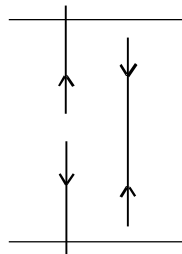

The test pattern is similar to the LAT-test. Check the quality of the cuts: the end of the vertical cuts should coincide precisely with the horizontal cuts, without any gaps.





Weed out the rectangle and if you obtained a pattern as illustrated above, decrease the value displayed on the LCD by pressing the  jogging key to correct closing of the lines cut.

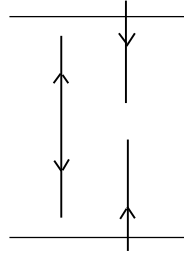

To repeat the test, press the  key.

Press the  key to repeat the calibration procedure or press the  key to interrupt the routine.



However, if you obtained a pattern as illustrated above, increase the value displayed on the LCD by pressing the  jogging key to correct closing of the lines cut.

To repeat the test, press the  key.

Press the  key to repeat the calibration procedure or press the  key to interrupt the routine.

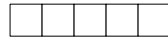

A complementary test has been added to fine tune the LONG. adjustment. Press the 1 key to perform the horizontal test; all the squares should be identical.

2.5.2. CUT BORDER

The CUT BORDER submenu is used to cut the border of the media area which was defined during the load sequence. This function is particularly useful if you want to verify the exact cutting area.

2.5.3. MENU PLOT

The MENU PLOT is a hard copy of the present cutter configuration, i.e. the items selected in the USER CONFIG submenus described in Section 2.3. The plot is organised by menu categories to show the current values for the various USER CONFIG 1(->4) configurations. To run this plot, load a sheet of plotting paper and install a pen.

NOTE

It is strongly recommended to produce a MENU PLOT hard copy each time you alter the cutter configuration. The resulting plot should be kept with the cutter documentation in order to provide other users with details of the actual configurations of the unit.

2.5.4. CONFIDENCE CUT

The CONFIDENCE cut performs an electrical and mechanical test of the cutter to make sure that the cutter is fully operational. A media sheet of at least A3/A- size should be used for this plot.

2.5.5. DIN CUT

The DIN CUT also performs an electrical and mechanical test of the cutter, in order to check the cut quality, but also provides the user with feedback on knife setting, knife pressure, knife offset and cutting depth.

This cut is always run as a DIN A4 portrait/A-size image, regardless of the actual size of the media loaded. If the media loaded is smaller than DIN A4/A-size, part of the outer box will be clipped (not cut). This cut is always executed in the sequence prescribed by the ISO DIN standard.

2.5.6. SYSTEM TESTS



The SYSTEM TESTS submenu covers the menu items you only occasionally need to adjust the cutting process.

Press the **ENTER** key to access the different submenu items which are explained in section 2.6 below.

2.6. SYSTEM TESTS

The SYSTEM TESTS menu is a special set of procedures which are not required for normal cutter operation. Field service personnel, however, will use the SYSTEM TESTS menu occasionally. When in SYSTEM TESTS, the cutter is fully operational and performs as described in this manual.

2.6.1. LANGUAGE

The MENU LANGUAGE submenu is used to set or modify the dialogue language on the LCD. Press the  or  jogging key until the desired language is displayed on the LCD and press  to confirm. The information on the LCD can be displayed in English, French, German, Dutch, Spanish or Italian.

2.6.2. ROM REVISION

Selecting the ROM REVISION option, by pressing the  key will furnish the details on the cutter' s ROM revision. This information is often helpful to technicians when diagnosing problems over the telephone.

2.6.3. SERVICE PLOT

The SERVICE PLOT provides information about the cutter, which is helpful when requesting service for your cutter. The SERVICE PLOT is always plotted at the same size and should be performed with a pen on paper.

The plot shows the cutter model number, the revision numbers of the installed ROM (Read Only Memory) circuits, the selected baud rate, the resolution and buffer (memory) size.



CAUTION

The following test routines are normally restricted to Summa Field Service Personnel.

2.6.4. SENSOR SETUP

The SENSOR SETUP option is a useful routine to check whether or not the front and rear media sensor are functioning properly and whether the switching levels of these sensors are correctly set.

2.6.5. CALIBRATION

Calibration allows the length of the lines cut to be adjusted to within the specifications.

For instance, if a cut line should measure 100 mm exactly, the cutter can be adjusted for any discrepancy.

2.6.6. TRACKING TEST

This test allows the tracking quality of the machine to be verified.

2.6.7. FRICTION PLOT

This test routine must be performed with a pen and is used to detect problems with the cutter. The FRICTION PLOT is automatically scaled to fit the currently installed paper size. This test should only be performed by qualified service personnel.

2.6.8. RS232 TEST

The RS232 TEST routine verifies the cutter' s RS-232-C serial communications (transmit data, receive data, and hardware handshaking) circuits. This test does not require pen, knife or media to be loaded.

➔ To run the RS-232-C test, proceed as follows :

1. Unplug the RS-232-C data cable from the rear panel of the cutter.
2. Use a loopback test cable to connect pin 2 of the cutter' s data connector to pin 3 and pin 7 to pin 8.
3. With RS232 TEST displayed, press the ENTER key. The cutter will start transmitting and receiving data at all available baud rates and parity settings. The length of the transmissions will vary because of the different baud rates used. The unit then checks the hardware handshake lines.
4. Upon completion of the test, remove the loopback test cable from the cutter rear panel RS-232-C connector.

5. Plug the RS-232-C data cable into the connector.

2.6.9. RAM TEST

This test completely checks the RAM bit for bit.

When running this test the cutter will not respond. After this test, power the cutter off, then on .

2.6.10. INSTALL MENU

The INSTALL MENU routine restores the factory-defined menu settings in all four USER CONFIG menus. This test routine can be performed without a tool and without media.

2.6.11. COIL SETUP

This test is used to calibrate knife and pen pressure and to set the knife and pen "landing".



After adjustment, the value is saved in the system' s non-volatile RAM.

To execute this test a tension gauge of ± 100 gr and ± 500 gr is required.

In the upper line of the display the desired pressure appears and in the bottom line of the display the value that has to be sent to the head to reach this pressure (this value is between 0 and 127).

2.6.12. LCD CONTRAST

The LCD CONTRAST submenu is used to adjust the contrast (or intensity) of the liquid crystal display on the control panel.

Press the  or  jogging key to increase or reduce the contrast and press  to confirm.

SECTION 3

GENERAL INFORMATION



3.1. MAINTENANCE & CLEANING

The SummaSign Pro cutter range has a number of sliding surfaces made of smooth metals and plastics. They are virtually friction-free and require no lubrication. They will, however, collect dust and lint which may affect the performance of the cutter. Keep the cutter as clean as possible by using a dust cover. When necessary, clean the unit with a soft cloth dampened with isopropyl alcohol or mild detergent. Do not use abrasives.

3.1.1. CLEANING THE DRIVE SYSTEM

After a time, the sleeves of the drive drum may become clogged with accumulated residue from the media. This situation may affect traction as the media will tend to slip between the pinch rollers and the drive sleeves.

➔ To clean the drive sleeves, proceed as follows:

1. First disable the sensors by covering them, or via the configuration menu (see 2.4.12 Media Sensor).
2. Place the cutter in local operation. (See Section 2.2.2.) Local operation will allow you to use the control panel jogging keys, even when no media is loaded.
3. Remove the backing from a piece of vinyl. Place the vinyl with the tacky side down between one of the pinch rollers and a drive sleeve. Lower the pinch roller arm.
4. Use the  and  jogging keys to move the piece of vinyl backward and forward several times, until all residue is removed from the drive sleeves.
5. Raise the pinch roller arm and remove the piece of vinyl media.

6. Repeat steps 3 through 5 for the other drive sleeves.
7. Set the cutter's power switch to OFF.

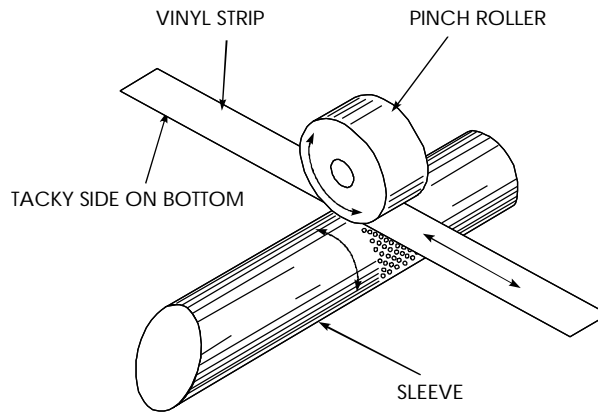

FIGURE 3-1:
CLEANING OF THE DRIVE SLEEVES

3.1.2. CLEANING THE SENSORS

After a certain time, the sensor may become dirty with accumulated residue from the media. This situation may cause malfunctioning of the cutter.

➔ To clean the sensor area, proceed as follows:

1. The sensors are located on the cutter's right side. One sensor is located on the front platen the other sensor is located on the rear platen.

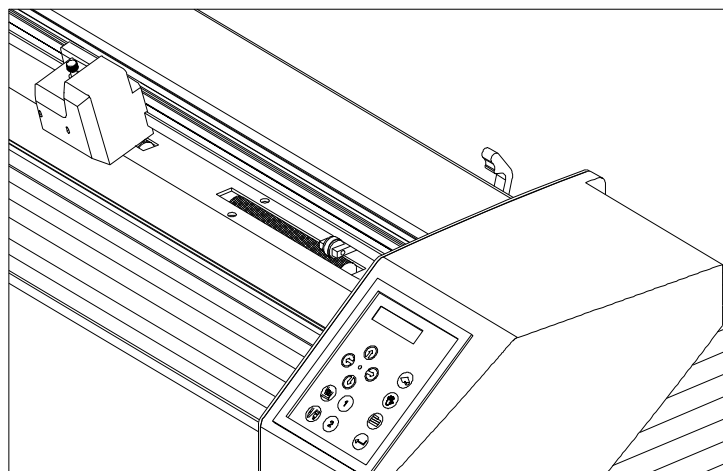

FIGURE 3-2:
LOCATION OF THE SENSORS

2. To keep the sensors clean, it is sufficient to wipe them out now and then with a cotton swab.

3.1.3 CLEANING THE NOSE PIECE

The nose piece may become dirty with accumulated residue from the vinyl and will result in poor cut quality.

➔ To clean the nose piece, proceed as follows:

1. Gently take out the knife or ball-point pen by turning the knife holder anticlockwise.
2. Observe the orientation of the nose piece first and then push it out of its holder.
3. Remove any remaining vinyl residue using a brush or a pair of tweezers.
4. Place the nose piece back .
5. Install the knife or ball-point pen holder as described in section 1.7.

3.2. OPERATING VOLTAGE CONVERSION

The power entry module cover shows four possible AC voltage settings (100 V, 120 V, 230 V and 240 V). The pin in one of the holes indicates the cutter's active voltage setting. If this setting does not match the voltage supplied to your site, you must change the voltage ***BEFORE*** powering on the cutter.

When changing the voltage setting, you will also have to change the fuses as appropriate to the voltage.

To change the fuse(s), remove the fuse(s) from the fuse box behind the cover plate of the power entry module.

For 100 or 120 V AC operation use only a 1.25 A Slo-Blo fuses.

For 230 or 240 V AC operation use only a 0.6A Slo-Blo fuses.

NOTE

Always make sure that you are using the correct fuses for your voltage selection.

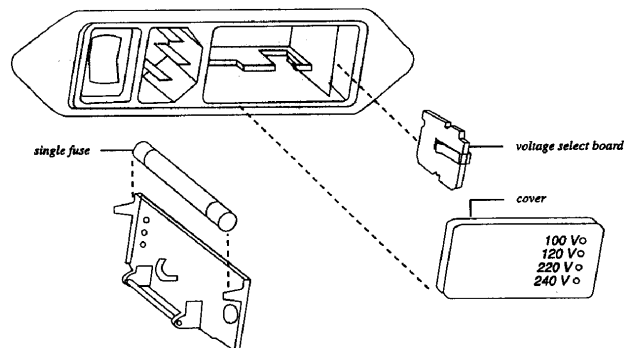

FIGURE 3-3
POWER ENTRY MODULE

SECTION 4

INTERFACE

4.1. INTRODUCTION

This section describes the signal connections for RS-232-C serial communication between your cutter and the host computer. When connecting the cutter to the host computer, always proceed as follows:

1. Refer to the cutting/plotting application software documentation and check the recommended cabling specifications.

If your cutter is not specifically listed, use the cabling specified for the Houston Instrument DMP-60C cutters.

2. If the documentation of the cutting/plotting software does not contain specific cabling instructions, use the Summa cable specifications recommended for your computer.

4.2. INTERFACE NOTES

4.2.1. SYSTEM SETUP

4.2.1.1. *MS-DOS or PC-DOS operating system*

➔ To set up your system, proceed as follows:

1. Boot up the operating system.
2. If the cutter is to be connected to serial port #1 (known as COM1) the port must be configured by entering the following command at the system prompt: `MODE COM1:9600,N,8,2,P.`
3. If the cutter is to be connected to serial port #2 (known as COM2) the port must be configured by entering the following command at the system prompt: `MODE COM2:9600,N,8,2,P.`

4. To redirect the output to serial port #1, enter the following command at the system prompt: MODE LPT1:=COM1:.
5. To redirect the output to serial port #2, enter the following command at the system prompt: MODE LPT1:=COM2:.
6. The computer end of the cable must be plugged into the serial port defined as COM1 (or COM2). The cutter's baud rate must be set to 9600, with parity NONE and RTS/DTR mode set to TOGGLE.

4.2.1.2. Windows 3.xx.

➔ To set up your system, proceed as follows:

1. Select "Main group" in the Program Manager. Select "Control Panel", then "Ports" and then the port that is connected to the cutter. Press the "Settings" Button to see the port settings.
2. The default settings of the cutter are as follow:
 - Baudrate : 9600 (see 2.4.7.)
 - Data Bits : 8
 - Parity : none (see 2.4.8.)
 - Stop Bits : 2
 - Flow Control : Hardware or Xon / Xoff

4.2.1.3. Windows 95/98

➔ To set up your system, proceed as follows:

1. Press the "Start" Button and select "Settings", continued by "Control Panel". Press on the "System" icon and select the "Device Manager" tab. Select the port that is connected to the cutter and click on the properties button. Select the "Port Settings" tab to set the port settings.
2. Analogous to 4.2.1.2.

4.2.2. SERIAL INTERFACE CONNECTOR ON CUTTER

RS-232C Serial Interface Connector		
<i>Pin n°</i>	<i>Signal</i>	<i>Description</i>
1	NC	Not Connected
2	RXD	Receive Data
3	TXD	Transmit Data
4	DTR	Data Terminal Ready
5	GND	Signal ground
6	NC	Not connected
7	RTS	Request To Send
8	CTS	Clear To Send
9	NC	Not Connected

4.2.3. PARALLEL INTERFACE CONNECTOR ON CUTTER

The use of a shielded parallel cable is required.

Parallel interface Connector			
Pin n°	Definition	Pin n°	Definition
1	-Data Strobe	19	Ground
2	Data 1	20	Ground
3	Data 2	21	Ground
4	Data 3	22	Ground
5	Data 4	23	Ground
6	Data 5	24	Ground
7	Data 6	25	Ground
8	Data 7	26	Ground
9	Data 8	27	Ground
10	-Acknowledge	28	Ground
11	Busy	29	Ground
12	Paper End	30	Ground
13	Select	31	-Input Prime
14	Not Connected	32	-Fault
15	Not Connected	33	Not Connected
16	Logical Ground	34	Not Connected
17	Chassis Ground	35	Not Connected
18	Positive 5V	36	Not Connected
<i>-Negative true logic</i>			

4.3. AVAILABLE SERIAL SIGNALS

If you are making your own cable, only a few of the cutter pins will actually need to be connected to the host computer. To ensure optimum results, the cable length should not exceed 4.8 m (16 feet). It should be taken into account that your computer or cutting software may also require additional loopback connections at the host computer's end of the data cable.

- Connect the Transmit Data (TXD) pin of the computer to pin #2 of the cutter.
- Connect the Receive Data (RXD) pin of the computer to pin #3 of the cutter.
- For hardware handshaking, connect the Clear To Send (CTS) pin of the computer to pin #4 or pin #7 of the cutter. Connect the Request To Send (RTS) pin of the computer to pin #8 of the cutter.
- Connect the ground (GND) pin of the computer to pin #5 of the cutter.

5. Contour cutting on the SummaSign Series cutters

5.1 INTRODUCTION

The SummaSign Series cutters have accurate alignment methods to guarantee precise contour cutting.



Depending on the selected alignment method, the cutters can counterbalance the following irregularities:

1. ROTATED DESIGN : If the printed design is not loaded straight into the unit, the contour can be rotated equally to fit the printed graphic.

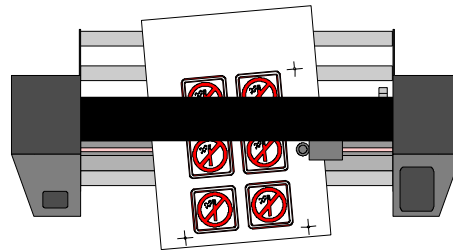

2. SKEWED DESIGN : If the X and Y axes of the printed design are not perpendicular, the contour can be skewed to fit the printed design.

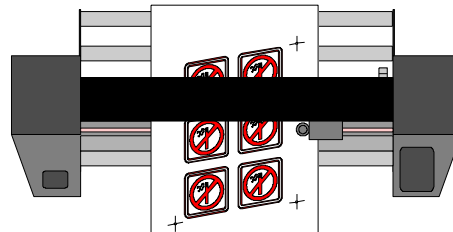

3. INCORRECTLY SCALED DESIGN : If the print size is different from the original design in your software due to media expansion or shrinkage, or due to printing inaccuracies, the contour can be scaled to fit the printed graphic.

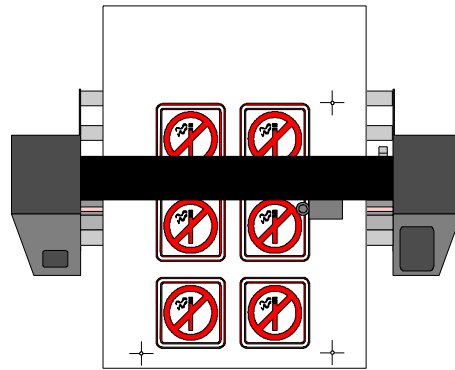

NOTE : The scaling can only be adjusted by a few percent.

→ Any combination of the three above irregularities can be handled too.

The parameter SPECIAL_LOAD in the user configuration menu determines which alignment method is used. This parameter can be changed with Summa Cutter Control or with the control panel.

- Using Summa Cutter Control to select the desired alignment method:

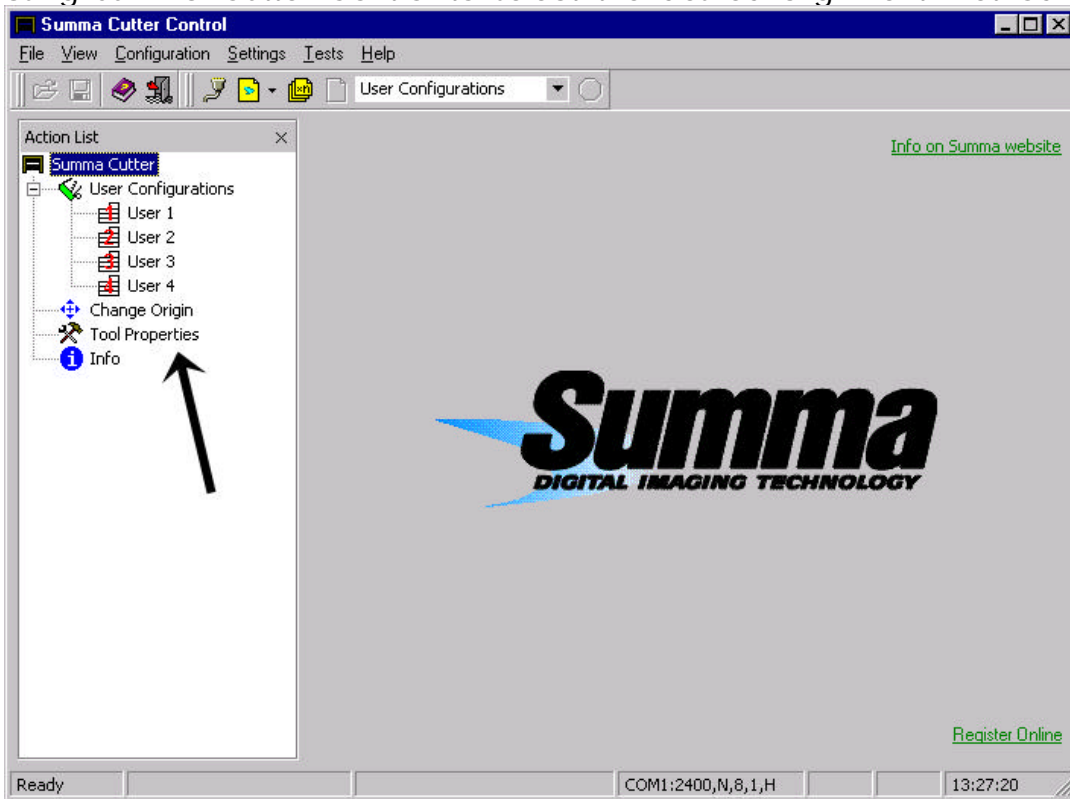

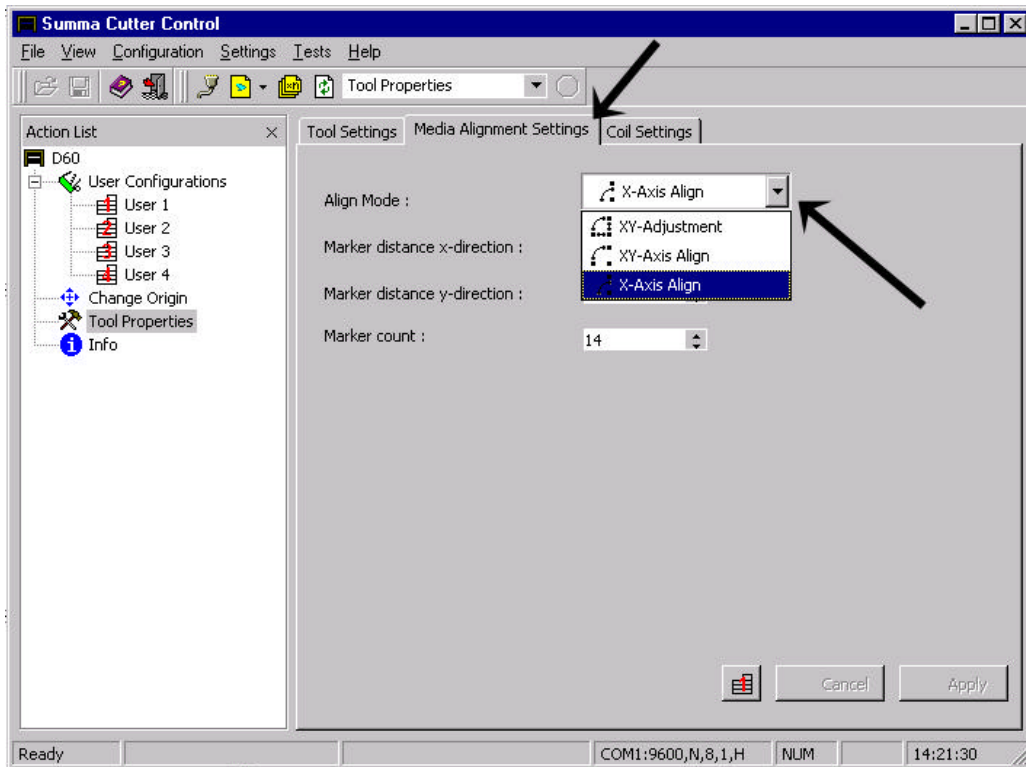

- Using the control panel to select the desired alignment method:

Press the  key (MENU) until the message 'USER CONFIG 1' is displayed on the LCD.



Press the  jogging key until the message 'SYSTEM SETUP' is displayed.



Press the  jogging key until the message 'SPECIAL LOAD' is displayed.



Press the  or  key to modify the special load parameter.

Press the  key to confirm the selection.

The alignment methods are based on the principle of cross-marks that are printed together with the drawing. These cross-marks can be of any type.

There are three alignment methods.

NOTE

The SummaSign Series cutters can also be equipped with an Optical Positioning System (OPOS). This automatic system guarantees precise contour cutting. The use of the OPOS is explained in a separate manual (MI9981).

Alignment methods:

1. **X-Alignment** : counterbalances a "rotated design" problem. For this method, the origin and one point along the x-axis must be specified. This method only rotates the contour. It does not require any distance parameters. This is the fastest and easiest method. It is advised to use this method with small sheets (up to A3 (11" x 17")).

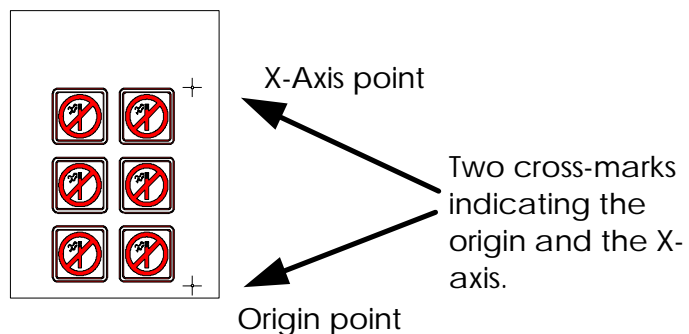

2. **XY-Alignment** : counterbalances the "rotated design" and "skewed design" problems. For this method, the origin, one point along the x-axis and one point along the y-axis must be specified. This method rotates and skews the drawing. It does not need any distance parameters. This method is the most precise method without using any distance parameters.

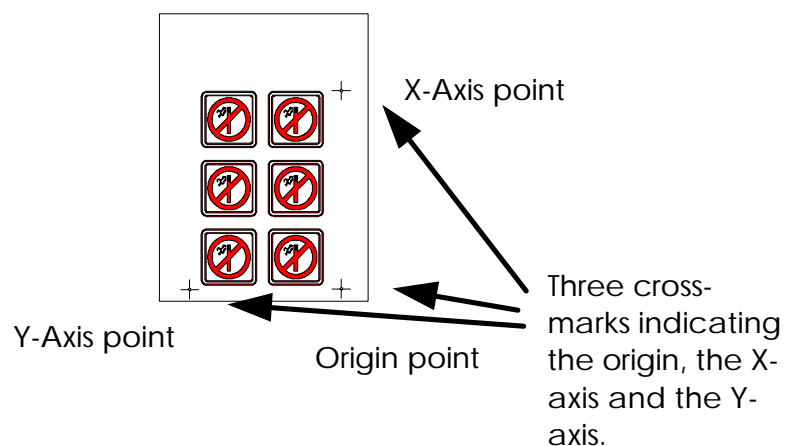

3. **XY-Adjustment** : counterbalances the "rotated design", "skewed design" and "Incorrectly scaled design" problems. For this method, the origin, one defined point along the x-axis and one defined point along the y-axis must be specified. This method rotates, skews and scales the drawing. It requires

two parameters ($x_distance$ and $y_distance$). These distances define the position of the two points along the axes. This is the most accurate manual alignment method.

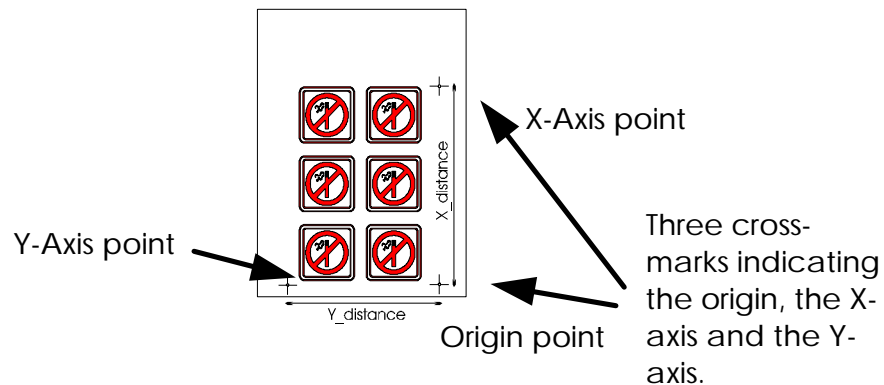

5.2 GENERAL

For accurate Contour Cutting with the alignment methods, proceed as follows:

- Create the design on which you want to perform the contour cut.
- Place cross-marks around your design.
- Print out the design with the cross marks.
- Load the printed design in the cutter and set the cross-mark parameters in the cutter (only when using the XY-adjustment method).
- Execute the special load procedure.
- Cut out the contour.

5.3 CREATING THE DESIGN

- Create in your software the design you want to print and Cut:



- Define the Contour:



⇒ Do not define the contour exactly on a printed line. This way it will not catch the eye if the contour has moved a little during cutting.



⇒ Place the contour on a separate layer, assign a unique color to it, etc. (refer to your software documentation), so that it is easy to select the contour or the design.

NOTE

Most dedicated sign-making software will provide some easier ways to do all this. Please contact your dealer.

- Make multiple copies if necessary (of both the design and the contour):



5.4 PLACING THE CROSS-MARKS

- Place two cross-marks indicating the X-axis.

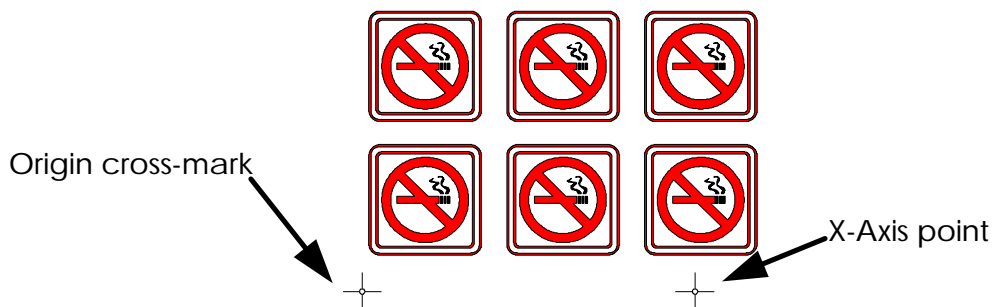

- ◆ Make sure that the origin cross-mark is situated completely at the left side and below all the contours that will be cut.
- ◆ Make sure that the two cross-marks are situated exactly at the same height.
- ◆ The cross-marks may be of any type.
- ◆ The exact distance between the two points that are indicated by these cross-marks must be known (only when using the XY-adjustment method). Do not measure these distances on the print out but measure them in the software!



⇒ Place the markers as far as possible from each other for maximum accuracy.

⇒ Place the cross-marks on a separate layer for easier handling.



- Place the cross-mark indicating the Y-axis (only when using the XY-Alignment and the XY-Adjustment method):

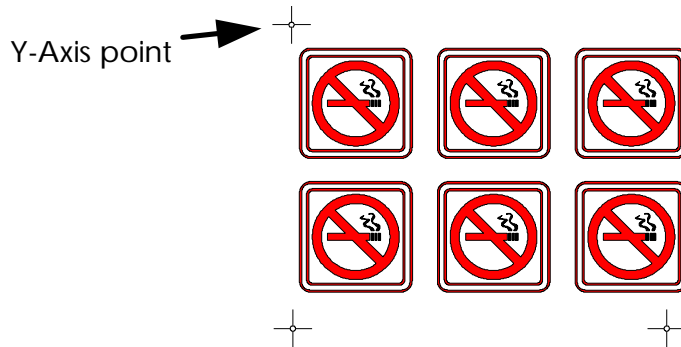

- ◆ Make sure that the cross-mark is placed exactly above the origin marker.
- ◆ The exact distance between the two points that are indicated by this marker and the origin must be known (only when using the XY-Adjustment method). Do not measure these distances on the print-out, but measure them in the software.

⇒ Place the markers as far as possible from each other for maximum accuracy.



5.5 PRINTING THE DESIGN

- Print the markers and the design with your printer.
- When printing on a roll, make sure that the orientation is as follows:

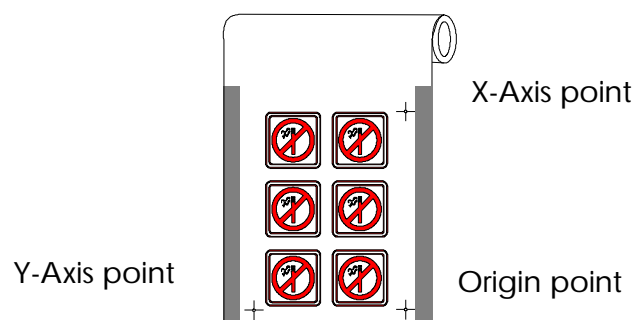

- ◆ Make sure that there is at least 1 cm, preferably 2cm margin (0.4", preferably 0.8") on each side.
- When printing on sheets or cutting off your print from the roll, make sure that there is a margin of at least 8 cm (3.15") at the end of the sheet:

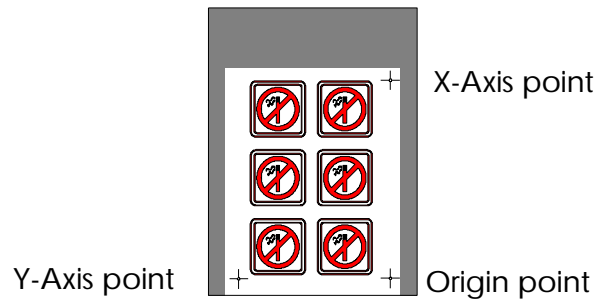

5.6 LOADING THE CUTTER AND SETTING THE PARAMETERS

- Load the print out in the cutter as described in the User's Manual. Make sure that the cross-mark indicating the origin is situated at the front right.

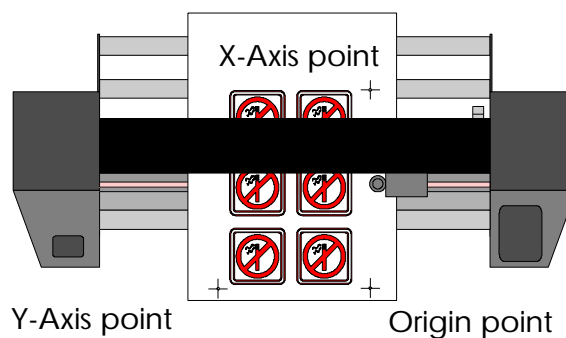

- If you have selected the XY-adjustment method (see above), then open Summa Cutter Control and select OPOS in the Configuration menu.

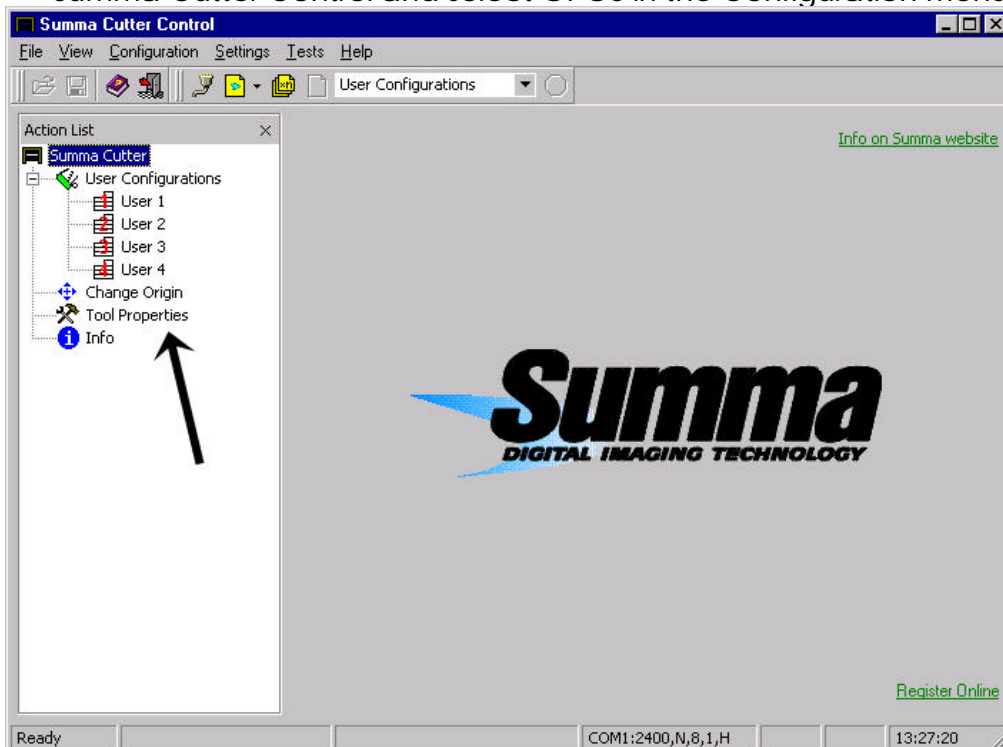

- ◆ Fill in the values for the marker distances and press OK:

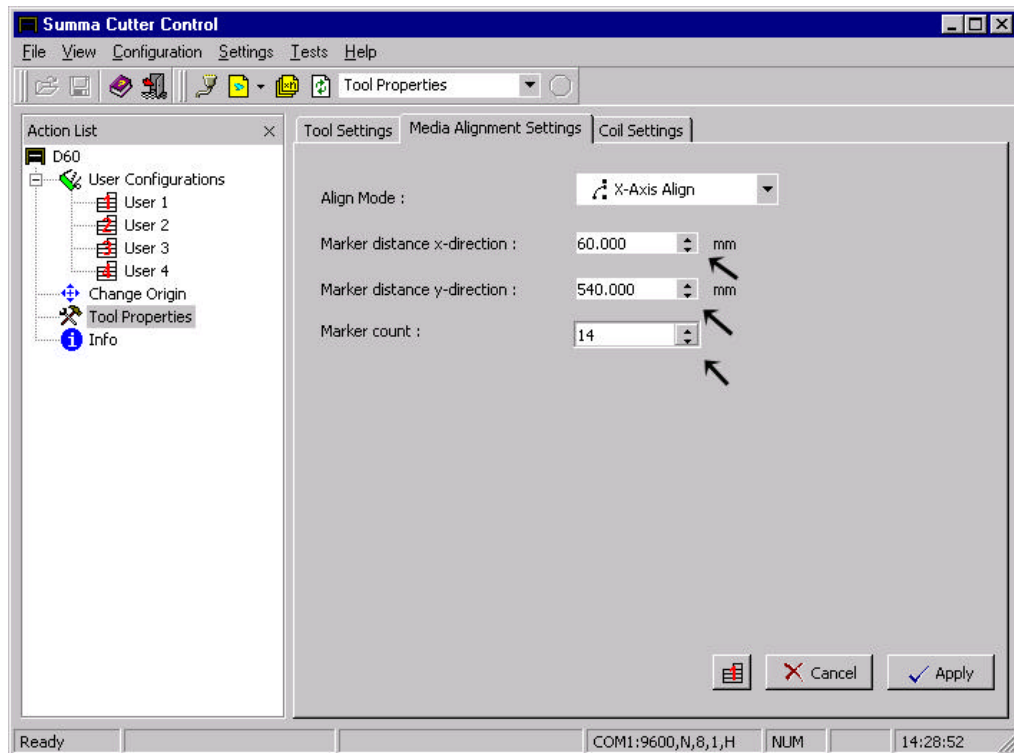





5.7 REGISTRATING THE CROSS-MARKS

- Before proceeding, make sure all the cutting parameters are correct (pressure, velocity, ...). See User's Manual.
- Press the  key until the message 'SPECIAL LOAD' is displayed on the LCD.

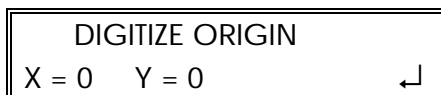



- Press the  key.

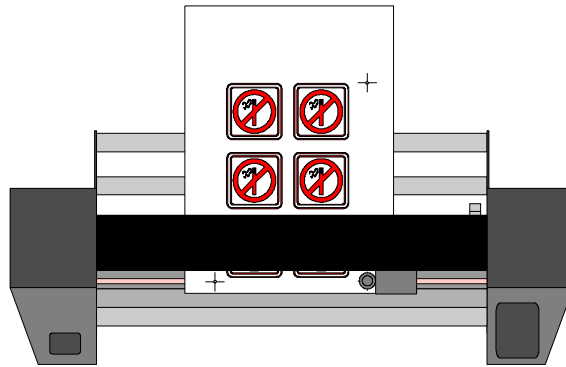

- Position the knife tip exactly above the origin-marker using the , , ,  jogging keys.

During this entire procedure, make sure that the knife does not rotate, which may cause an offset error.
Indicate the cross-marks with extreme accuracy because it directly influences the result.





- Press the  key.

DIGITIZE POINT		
X = 100	Y = 0	

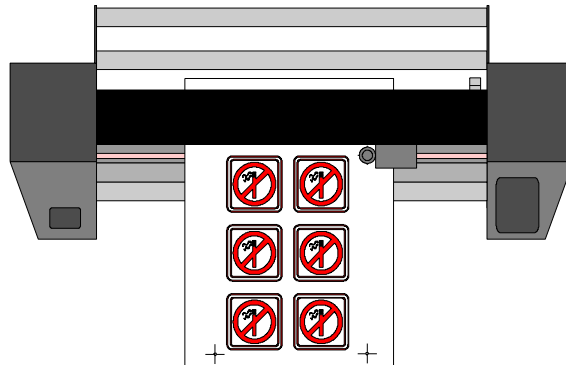
- Position the knife tip exactly above the mark indicating the X-axis.



- Press the  key. If the X-axis-alignment method has been chosen, the special load procedure will stop here. For the two other methods: position the knife tip exactly above the cross-mark indicating the Y-axis. Press the  key.

DIGITIZE POINT		
X = 0	Y = 100	

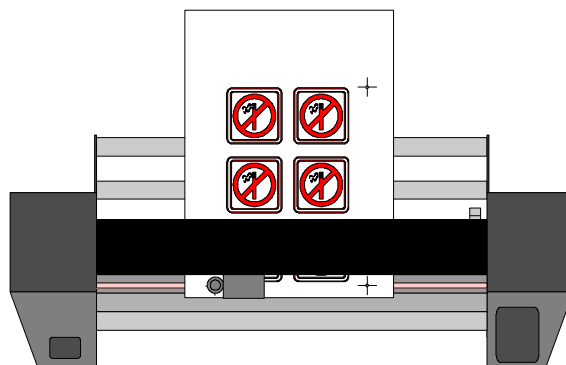

5.8 CUTTING THE CONTOUR

- Follow the specific instructions for contour cutting in your software. If there are no such instructions, follow the explanation below.
- Move the entire design (cross-marks and contours included) in your software so that the origin mark is situated in the lower left corner of the cutting area (In most sign-making software the orientation is landscape. If not, you will have to rotate everything).

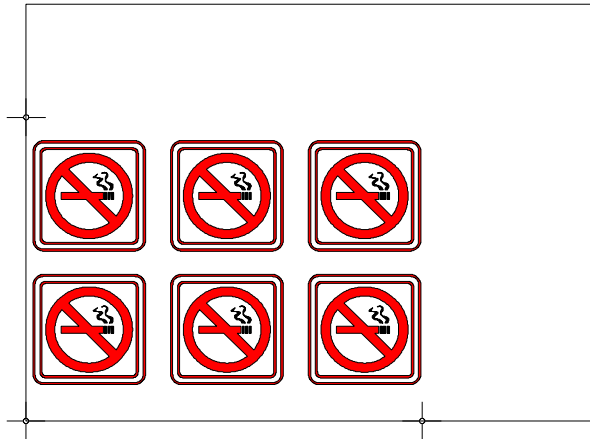

- Select the contours and cut them out:

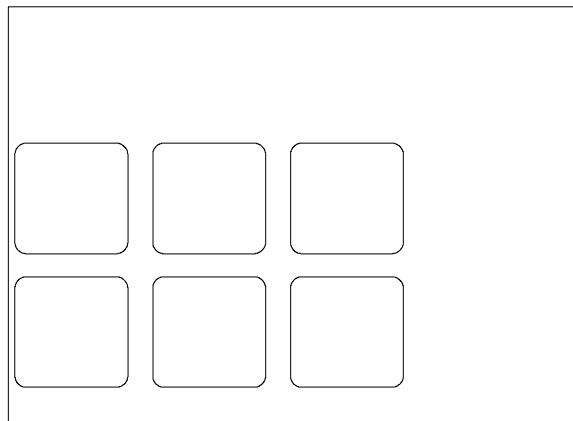

- ◆ Make sure that only the contours are cut.
- ◆ Make sure that the origin of the cutting area is used.



⇒ Some software will shift the selected contours to the origin when cutting. This can be avoided by adding a small rectangle that has its lower left corner right in the origin. Select this rectangle together with the contours.

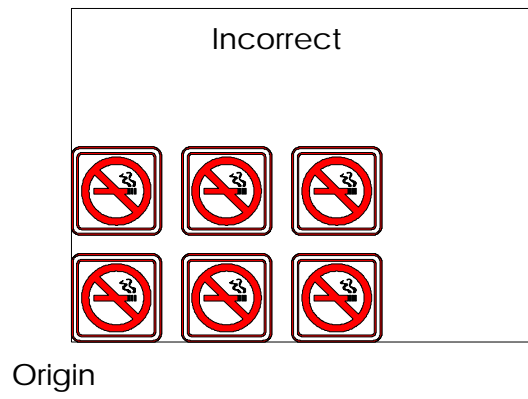
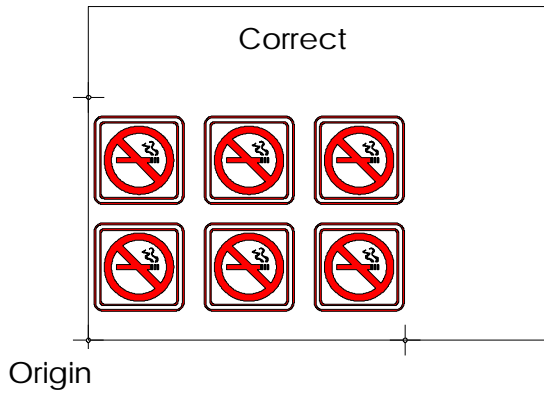

APPENDIX A

MEDIA CERTIFICATION

Types of media

A wide range of vinyl types has been evaluated and extensively tested on the SummaSign Pro T-series cutters. To ensure operation in compliance with the functional specifications of the T-Series cutters as listed in Section 1 of the User's Manual, only duly certified media should be used.

An alphabetic list of all duly certified media is included below. Before using other media, please contact your local Summa representative for advice.

Manufacturer	Type
3 M	Scotchcal Series 100 Scotchcal Series 3480 Scotchcal Translucent Series 3630 Scotchcal Special Effects 210 Controltac Series 170 Controltac Series 180
APA	
ARLON	Series 2100 Series 2500
FASSON	Economy Fascal 900 High Performance Fascal 4500 Translucent Fascal 8800 Intermediate Rubyscreen
GRAFITACK	Economy 100 Series 200 - 300 Series Transparent
KAPCO	High Performance Cast Vinyl Intermediate K5000
MACTAC	MaCal 8900 MaCal 9700 MaCal 9800

MULTIFIX	Series 1000 Series 5000 Series 7000
MULTISTIQ	Series 4500 Series 4600 Series 4700
PMF	Series 500 - 600 - 700
TESA	Tesacal 4196
X-FILM	Economy

SUMMA ADDRESSES

Americas and Asia Pacific

Summa Inc.
10001 Lake City Way NE
SEATTLE, WA 98125
USA

Tel +(01) 206-527-1050
Fax +(01) 206-527-1046

E-mail support@summausa.com

Europe

Summa NV
Rochesterlaan 6
8470 GISTEL
Belgium

Tel +32 59 270011
Fax +32 59 270063

E-mail summanv@summa.be